



WHERE MAGIC HAPPENS...





TABLE OF CONTENTS

DESIGN STYLES	12
Crystal Lounge	14
Pure Essence	16
Idyllic Garden	18
Earth Oasis	20
Spiritual Harmony	22
Tech Cocoon	24
PATIO PERGOLAS	29
Camargue®	30
Camargue® Skye	30
Algarve®	76
Algarve® Canvas	76
Aero®	94
Aero® Skye	94
Lapure®	108
Applications for condos, co-ops and apartments	114
Applications for urban gardens	124
Applications with storage	131
Customization	135
CARPORTS	161
Algarve® Canvas	162
GARDEN ELEMENTS	171
Lighting - Linarte outdoor light	174
Seating & planter unit - Linarte modulo	176
Freestanding wall - Linarte icon	178
Esafe - package drop mailbox	181
COMPLETE CONCEPTS	
Complete concepts for homes	182
Complete concepts for for condos, co-ops and apartments	192
FAQ	201
TECHNICAL INFORMATION	217
RANGE	232
NOA OUTDOOR EXPERIENCE CENTER	234

ENJOY YOUR PATIO, DECK AND GARDEN ALL YEAR ROUND...

A Renson outdoor room allows you to make the most of your patio and backyard - all year round. Naturally, once you have one, you will want to spend as much time in it as possible. Whether it's barbecuing with friends, enjoying the sun, or spending some quality me-time or time with your family in the peace and quiet, spending more time outside, experiencing those great moments is a real pick-me-up.

In the past, a home extension simply meant a well-insulated add-on to the living room. However, those days are over...

These days a whole new experience awaits, as a Renson outdoor living room creates a seamless link between your home and garden. It is a genuine additional living space, where you can enjoy the fresh, outdoor air in complete comfort. From spring to fall, and even throughout the winter months.

When it comes to styling and design, Renson gives you free rein to arrange everything to suit your personal preferences, with countless options for accessories, colors, and materials. You can also choose one of our six new 'Design Styles'; perfectly combined materials and colors, created for you by a famous international trend watcher.

In addition to the cover and all the related accessories, Renson also has a whole host of other products for the outdoor space around your home - from landscape lighting to carports.

Would you like to extend the same unique, gorgeous style from your front yard to the back yard in 1 design, 1 uniform color palette and 1 style? This is now possible, thanks to Renson outdoor products, even if you want to develop your outdoor space in stages.

We therefore invite you to read this brochure to discover the endless possibilities for transforming your patio and outdoor environment into an enchanting haven.

PERFECT OUTDOOR CLIMATE, DAY AND NIGHT

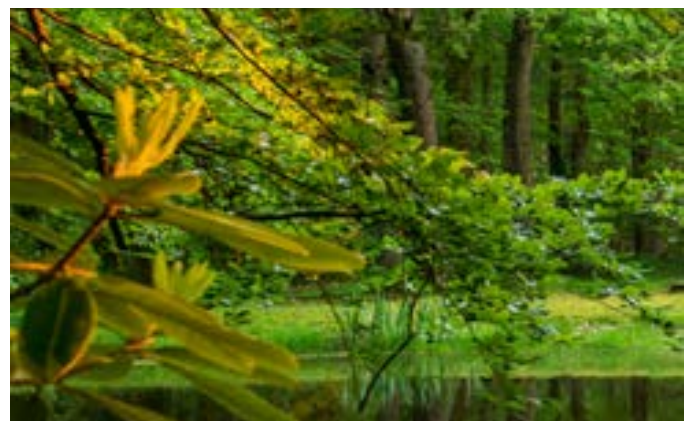
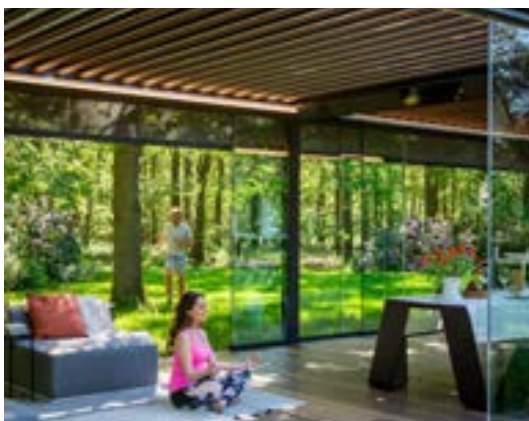

RENSON® IS FOR ALL SEASONS



Summer



Fall



Winter



Spring

ENDLESS POSSIBILITIES

Glamping



*Cooking
& Dining*



Man cave



FOR WORK AND
PLEASURE

| '24/7'

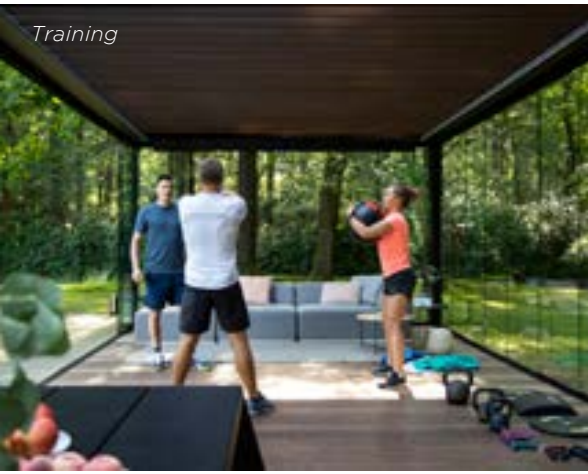

Training



Children's party



Office



Party



WHY CHOOSE RENSON®?



TOP QUALITY AND DURABILITY

Renson® is the European trendsetter in the field of natural ventilation, outdoor sun protection, and outdoor products. Our high-quality products are manufactured in-house at our ultramodern production facilities. We put our products through rigorous tests under the most extreme conditions to ensure that the end result is flawless.

This testing process means our customers can rest assured they're investing in the highest quality. With our network of well-trained Ambassadors, we can guarantee a flawless service, installation and aftercare experience. Our professional approach extends to every aspect of our business.



MINIMALIST DESIGN

Our products are highly innovative in both their look and design. Seamless integration of optional elements, hidden fixation parts, durable materials, and smart solutions combine into a perfectly finished product that can be integrated into every type of home.



ENDLESS CUSTOMIZATION POSSIBILITIES

With our modular product design and countless integrated options, we can offer you the perfect customized solution. Customizable screens, a wide choice of colors, sliding panels in various designs, glass walls, heating, and music are just a few of the options that allow you to create a unique personal solution.



ULTIMATE EASE OF USE AND MAINTENANCE

Our products are designed to retain their quality and ease of operation for many years, in all types of weather, day in, day out.

To ensure you can enjoy our products every day with as little maintenance as possible, we use materials of the highest quality that are guaranteed to last.

CREATE YOUR OWN AMBIENCE WITH OUR 6 DESIGN STYLES

At Renson, we love the outdoor lifestyle. Barbecuing with friends, relaxing in the sun, or taking some time out for yourself with drinks and tapas – it's about choosing quality of life. To elevate your outdoor living experience to a whole new level, Renson creates outdoor architecture that is both functional and beautiful. Our outdoor concepts are a perfect match for your home and blur the boundary between indoors and outdoors. As a result, nature and architecture blend seamlessly.

Naturally, we guarantee the highest quality standards. We do this by having our products tested and certified according to the strictest standards. Patented technology is one of the methods we use to accomplish this. But at the end of the day, it's our years of experience that really make us unique. After all, Renson has been a family business since 1909. Few can make that claim.

However, we take it a step further than quality. We also believe your freedom of choice is of paramount importance. Our products are fully customizable, so you are sure to find your style within our range. Haven't made up your mind entirely about what you want yet? Then get ready to discover a number of style ideas in this brochure to inspire you. The materials and colors of each style have been selected to balance perfectly with the complete look. That way you can get the most out of your outdoor space, year after year.



CRYSTAL LOUNGE

Crystal Lounge is sleek and minimalist. The fresh green tones create an airy feeling, which is further enhanced by the light material palette. The result is a modern, light architecture that blurs the boundaries between indoors and outdoors.



A outdoor living room is like an ongoing feature film starring nature. Enjoy the sight of the sun through branches, or how your plants gently move in the wind.



Fresh, poetic colors underpin Crystal Lounge. The color palette varies in shades from greenish beige to aqua green and a bright green grey. Matt glass provides transparency, while fine woven textures further enhance the airy feel. The materials in this style are fluid and seamless. Nothing disturbs the harmony, so that the architecture of Crystal Lounge blends perfectly with the surrounding nature.



Crystal Lounge is a style for true nature lovers, as the beauty of flora and fauna are at the heart of this design.



Camargue®
Frame RAL 7035
Blades RAL 9010
Zipshades N-0207
Loggiolu Plano RAL 7035
Curtains, Fine woven Jadeite
Glass sliding panels Matt glass

PURE ESSENCE

Pure Essence: an oasis of light and space. The pale colors and soft finishing give this style a feather-light feel. They create a place perfect to make the world go away, a space where you can completely unwind.



Pure Essence focuses on the essentials: sharing beautiful moments with friends and family, surrounded by nature. With Pure Essence, you can leave your daily troubles behind and savor pure indulgence.



Camargue®
*Frame and blades Beige Essence Retreat
Zipshades SC 2002
Loggiascreen Canvas Mixtrim 10 M0010
Loggiawood Thermo-es
Curtains, Refined woven White Corn*



Chalk, sand and natural shades of white set the tone in Pure Essence. Think of the soft white of cotton, the delicate beige of a shell, or the mild ivory blush of soap. Subtle tonal shades create an almost ethereal, light mood in which you can totally relax. The variations of textures reflect and diffuse the light, while the natural finishing and materials ensure this style is not too stark or cold.

IDYLLIC GARDEN

Idyllic Garden takes you on a stroll through the garden. Sober greys and subtle greens inspired by plants give this style a contemporary look and ensure you can relax surrounded by nature.

Camargue®
Frame & blades RAL 7032
Zipshades SC 2050
Loggiawood Privacy Thermo-es
Curtains, Refined woven Planton



The matt green of olive leaves, the nuanced sand color of travertine, the lively texture of linen: Idyllic Garden owes its ambience to the carefully selected range of natural materials. An elegant, airy character with a Mediterranean touch is the result. With its predominantly cool grey colors, Idyllic Garden offers refreshment and a timeless look.





The human eye can recognise more shades of green than of any other color. Green also has a relaxing effect. This is why we selected a varied palette of harmonious green tones for Idyllic Garden.



EARTH OASIS

Earth Oasis makes you feel as if you're always on vacation. The warm earth tones evoke the feeling of summer. Natural and artisan materials connect you to the richness of the earth, and ensure perfect harmony between indoors and outdoors.



The warm colors and materials associated with the Mediterranean region were our inspiration for Earth Oasis. The subtle soft orange-pink terracotta, and the powdery brown of spices were just a few of our references when compiling this palette. These rich hues will transport you to far-away sun-drenched regions.

Terracotta literally means ‘baked earth’. It has been used to make vases and pitchers for centuries. This material is once more fully on trend, and enchants with its natural, artisan look.



Camargue®
Frame & blades RAL 8024
Zipshades SC 1006
Loggiawood Thermo-es
Curtains, Thick woven Savannah Yellow



SPIRITUAL HARMONY

Spiritual Harmony - a minimalist style in a dark color palette. For the colors and materials, we drew inspiration from traditional Japanese architecture. The result is an intimate contemporary architecture that balances body and soul.



Spiritual Harmony's color palette is inspired by the colors and materials found in ancient Japanese temples. We combine blackened wood and walnut with visible grain, canvas beige and olive green. These dark, natural tones create a protective, calming atmosphere.





Camargue®
 Frame RAL 7021
 Blades Wooddesign Walnut
 Zipshades N-3006
 Loggiascreen Canvas Mixtrim 10 M0017
 Loggiawood Thermo-es
 Curtains, Refined woven Beige Brown



A garden pavilion allows you to savor each season to the fullest. You will experience the energy of spring and the richness of fall as never before.



In Japan, drinking tea is an intricate ritual. The traditional tea ceremony takes several hours and consists of a precise sequence of meticulously executed steps. But now you no longer need to travel thousands of miles: instead, enjoy your daily cup of tea and take advantage of a moment of reflection in your own garden.

TECH COCOON

Tech Cocoon is radically contemporary and young, but with a warm side. Contemporary design converses with dynamic, playful colors such as soft coral. A feeling of pure transparency predominates, with an emphasis on technical materials such as glass and steel.



Full of energy and as fresh as the scent of a freshly peeled citrus fruit – that’s Tech Cocoon. This refreshing style gives your garden room a bold urban look.



Tech Cocoon calls for young design with a certain flair. The gradations of shades ranging from soft coral to terracotta pink give this space a wonderfully relaxed, Mediterranean feel. Allow yourself to be inspired!



In Tech Cocoon, the playful textures of composite materials set the tone. Varying tones of terrazzo are combined with clean, smooth textures. The color palette is a combination of an energetic soft coral tone complemented by variations of white and soft grey with a greenish undertone. The orange-pink gives a warm and youthful accent to this sleek style.



Camargue®
 Frame & blades RAL 9010
 Zipshades N-0202
 Loggiolu Plano RAL 9010
 Curtains, Fine woven Ecrú
 Glass wall

FOR EVERY SEASON, FOR EVERY STYLE



Summer: Earth Oasis



Fall: Idyllic Garden



Winter: Spiritual Harmony



Spring: Crystal Lounge



Camargue®
Frame & blades RAL 7021
Zipshade Sergé SC0130
Loggiawood Privacy WRC



PERGOLAS

Thanks to a Renson® pergola, you can enjoy your outdoor space even more. There are numerous options to offer protection from the wind, sun, rain, or cold and a wide range of expansion and customization features. This makes your backyard, patio or patio a natural extension of your home so that you can spend time outside in optimal conditions and the greatest comfort.



CAMARGUE® LINE

CAMARGUE® & CAMARGUE® SKYE

The highest quality in an ultra-minimalist design.

Perfection is just around the corner.

Everything has been seamlessly integrated, from the screens in the side to the lighting, heating and music... This is luxury at its finest.

Enjoy the perfect temperature, morning, noon, and night - from summer to winter.



Camargue®
Frame & blades RAL 9016
Zipshade Sergé SC0202



CREATE YOUR OWN
ATMOSPHERE

Camargue®
Frame & blades RAL 9016
Zipshade Sergé SC0202





Camargue®
Frame & blades RAL 9016
Zipshade Sergé SC0202



DAY & NIGHT





Camargue®
Frame RAL 7016
Blades RAL 9010
Zipshade Sergé SC0130
Glass wall

Screens



Blades

closed



easily adjustable opening



open





Camargue®
Frame RAL 8019
Blades Alest essential Halo 136
Loggiolu Plano RAL 8019
Loggiascreen Canvas Mixtrim 10 M0017



CUSTOMIZATION
CATERS TO
EVERY TASTE





Camargue®
Frame RAL 8019
Blades Alesta essential Halo 136
Loggiascreen Canvas Mixtrim 10 M0017

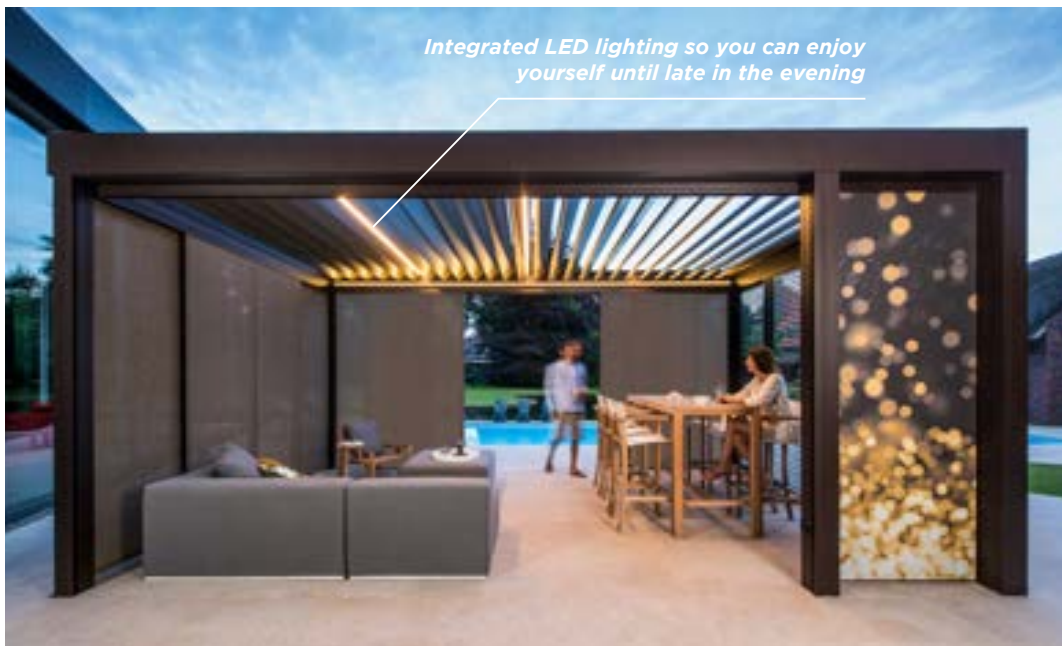

Integrated LED lighting so you can enjoy yourself until late in the evening

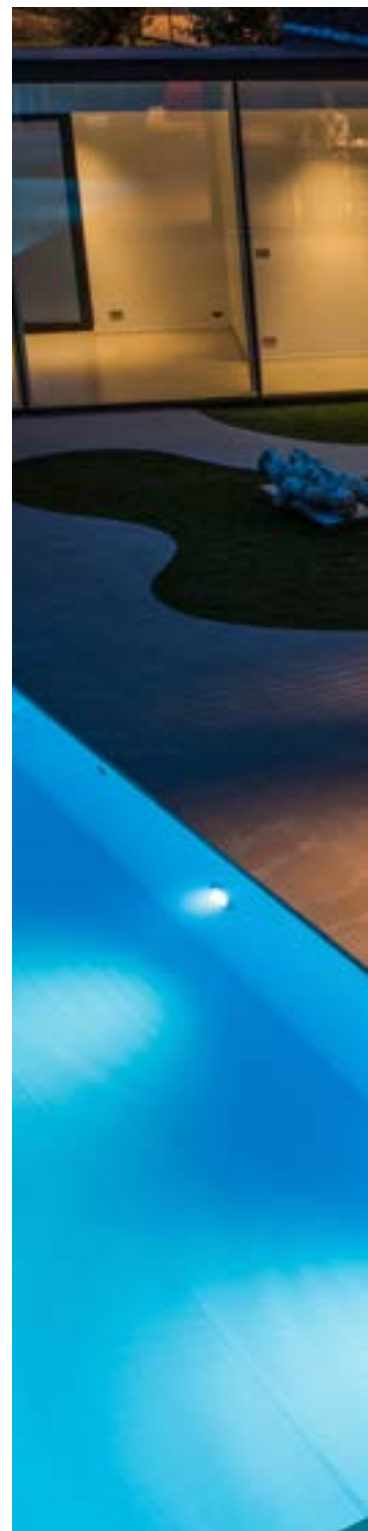

Perfectly customizable side screens (printed with your own design) are adjustable up to any height and are extremely windproof

Camargue®
 Frame RAL 8019
 Blades Alesta essential Halo 136
 Loggiolu Plano RAL 8019
 Loggiascreen Canvas Mixtrim 10 M0017



| IN PERFECT
| HARMONY



Camargue®
Frame & blades RAL 7021
Zipshade Sergé SC0130
Loggiawood Privacy WRC





Camargue®
Frame & blades RAL 7021
Zipshade Sergé SC0130
Loggiawood Privacy WRC





Camargue® Skye
Frame & blades RAL 9005
Loggiawood Privacy WRC



ENJOY BOTH TODAY
AND TOMORROW





| INSIDE IS OUTSIDE,
 | OUTSIDE IS INSIDE

Camargue® Skye
Frame & blades RAL 9005
Loggiawood Privacy WRC





Camargue®
Frame & blades RAL 9016
Zipshade Serge SC0202





AN EXTENSION
AGAINST OUR
OUTER WALL IS
PERFECTLY POSSIBLE





EVEN MORE ENJOYMENT

After living in the heart of the city for years, we built our dream home in the suburbs a few years ago. Finally, we had a garden, a quiet setting, and nature that gives us both a sense of peace. But we were unable to enjoy our garden to the fullest. Spring is often windy. While in the summer, it occasionally gets too hot.

In late summer, the evenings cool down quicker and showers become more frequent. But thanks to our pergola, we can now enjoy spending much more time outside. The side construction protects us from the wind. The screens can be set to the desired height in the summer. And if there's a sudden shower, we just close the roof blades.

The result is that we can spend an amazing extra number of hours outdoors after work. Now our garden has really become an invaluable asset that gives us a much better quality of life.

Brad & Monica



Camargue®
 Frame & blades RAL 9016
 Zipshade Sergé SC3030



IN PERFECT HARMONY

Camargue®
Frame RAL 9005
Blades Wooddesign walnut
Loggiolu Wooddesign walnut
Linus RAL 9005



HEALTHY BODY, HEALTHY SOUL



Camargue® Skye & Camargue®
Frame RAL 9005
Blades Camargue Skye: RAL 9005
Blades Camargue: Wooddesign white oak
Zipshade Sergé SC3030
Loggialu Privacy Wooddesign white oak
Linarte RAL 9005



Linarte® Façade cladding



PERFECTLY INTEGRATED EXTENSION

Camargue®
Frame: RAL 7021
Blades: RAL9010
Loggia privacy
Glass sliding panels





Camargue®
Frame & blades: RAL7016
Loggiawood Privacy WRC





Camargue® & Camargue® Skye
Frame RAL 9004
Blades Wooddesign walnut
Zipshade Natté N3006
Glass wall



ENJOY IN
ALL SEASONS
FROM FALL...



Camargue® & Camargue® Skye
Frame RAL 9004
Blades Wooddesign walnut
Zipshade Natté N3006
Glass wall





Camargue® & Camargue® Skye
Frame RAL 9004
Blades Wooddesign walnut
Zipshade Natté N3006
Glass wall

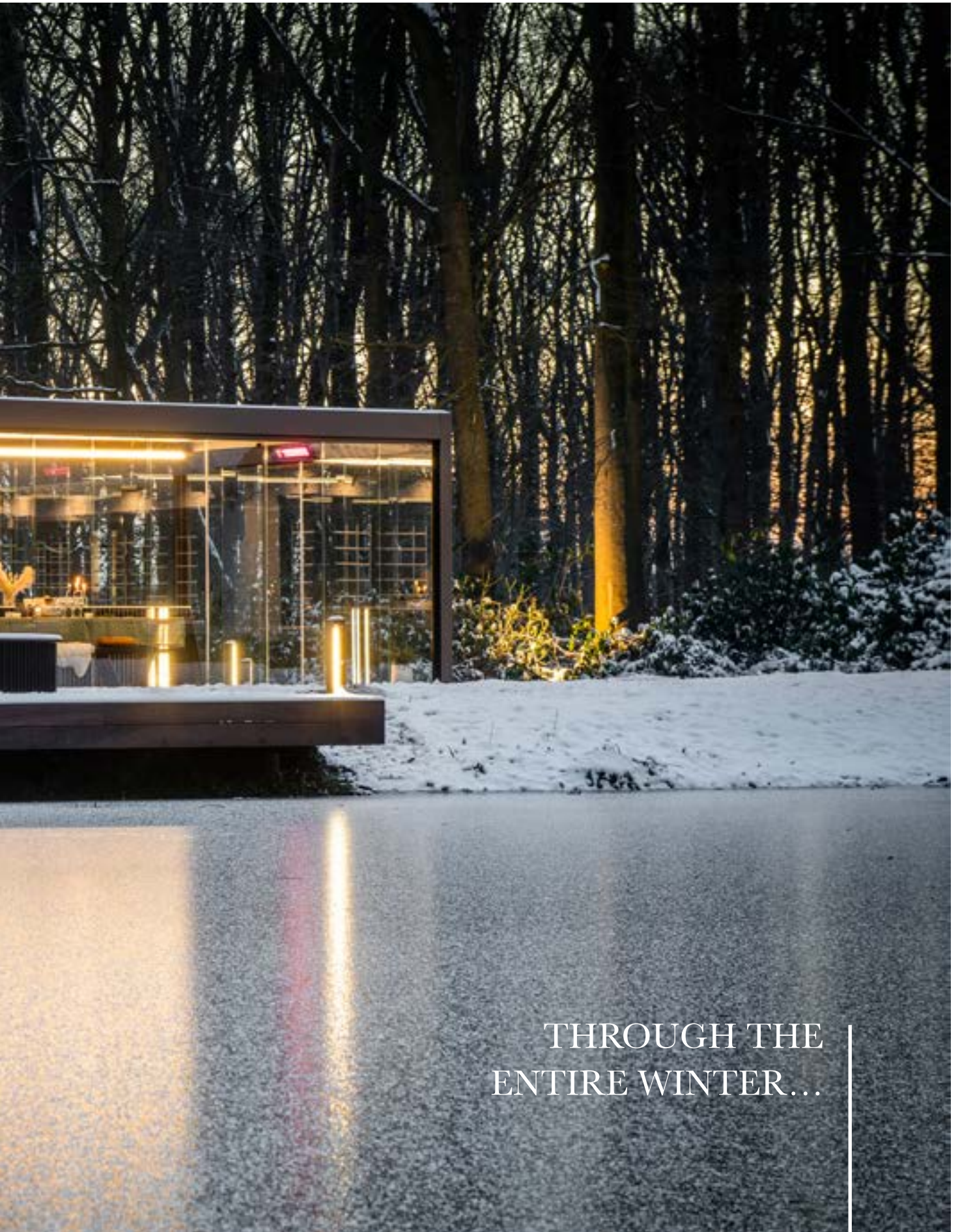

THROUGH THE
ENTIRE WINTER...



Camargue® & Camargue® Skye
Frame RAL 9004
Blades Wooddesign walnut
Zipshade Natté N3006
Glass wall



AND INTO SPRING...



Camargue® & Camargue® Skye
Frame RAL 9004
Blades Wooddesign walnut
Zipshade Natté N3006
Glass wall



AND ALL SUMMER LONG...
ENJOY YOUR BACKYARD, PATIO
AND DECK ALL YEAR ROUND!

Camargue® & Camargue® Skye
Frame RAL 9004
Blades Wooddesign walnut
Zipshade Natté N3006
Glass wall







ALGARVE® LINE

ALGARVE® & ALGARVE® CANVAS



This gorgeous minimalist solution goes with every style, and you can choose whatever color you like at no extra cost. All accessories are perfectly made-to-measure. This is enjoyment - pure and simple - without a care in the world.



Algarve®
Frame & blades RAL 7037



Algarve*
Frame & blades RAL 7037





Algarve®
Frame & blades RAL 7037



A MORE STRUCTURAL SOLUTION

We wanted a fixed pergola to protect us from the sun or rain whenever we needed it. We thought that this pergola was an excellent fit with the existing architecture of our house and it seemed like a sound solution. It has turned out to be even more comfortable than we had expected. We should have installed it years ago. The blades rotate anyway you like. When it's too hot, we open them slightly so we can feel the breeze. When it rains, the water drains away in no time. We've been using our pergola for five seasons, but it still looks like new. It's an incredibly solid construction. I clean the blades with Renson 'Clean' once every spring and reapply Renson 'Protect' to everything, and then we're set for a great new season.

Bryan and Tiffany



Algarve®
Frame & blades RAL 7037





Algarve® Classic Line
Frame & blades RAL 8003
(not made in the usa)



CLASSIC IS ALSO POSSIBLE





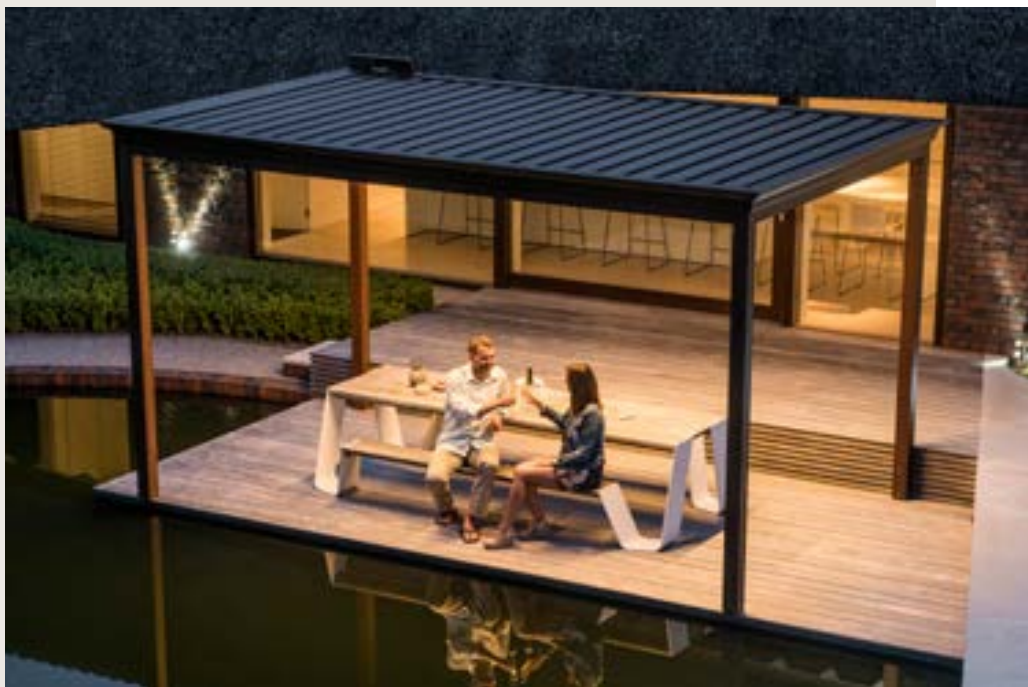

Algarve® Classic Line
Frame & blades RAL 8003



Algarve® & Algarve® Canvas
Frame & blades RAL 7006
Pearl Linen Canvas
Zipshade Sergé SC3231

ENJOY YOUR GARDEN TO THE FULLEST





Pergola

Algarve® & Algarve® Canvas
Frame & blades RAL 7006
Pearl Linen Canvas
Zipshade Sergé SC3231



Carport



ONE UNIFIED
LOOK AND FEEL





A COVER WITH A FIXED ROOF,
THIS WAS PERFECT FOR US

Algarve® Canvas
Frame & blades RAL 7016
Pearl Grey Canvas
Zipshade Sergé SC0130
Loggiawood Privacy WRC



AERO[®] LINE

AERO[®] & AERO[®] SKYE



The architect seamlessly integrated the bladed roof into the design of our pool house. The technology of our 'Skye' is out of this world. The blades open and slide out of sight, hardly making a sound.

Too hot? Just open the blades.

A rain shower? Simply close the blades. It's all app controlled.

Premium design. Overwhelming luxury.



Aero®
Frame & blades RAL 9005



WOOD FINISH



INTEGRATION INTO FLOATING STEEL STRUCTURE

Aero®
Frame RAL 9016
Blades RAL 9016







Aero®
Frame & blades: RAL9005





FINISH WITH ALUMINUM PANELS



Aero®
Frame & blades RAL 9010

SEAMLESS INTEGRATION
FOR A REFINED LOOK



Aero®
Frame & blades RAL 9001





THE ULTIMATE FEELING OF LUXURY



Aero® Skye
Frame & blades RAL 9005



LAPURE®

A slanted cover was a must for us because that what fits best with our home. However, finding an aesthetic option for that type of roof was tricky. We had a long search before finally finding Lapure. But we knew it was the right choice for us straight away. It remains taut even in high winds, and provides a perfect shield from the rain. The added value to our home is undeniable.



Lapure®
Frame RAL 7016
Canvas SW96 anthracite

ENJOY
YOUR GARDEN



Lapure®
Frame RAL 7016
Canvas SW96 anthracite







Lapure®
Frame: RAL7030
Canvas: SW96 anthracite





Camargue®
Frame & blades RAL 7021
Loggiolu Privacy RAL 7021

ALSO IDEAL FOR
CONDOS, COOPS AND
APARTMENTS ROOFTOPS





Algarve*
Frame & blades: RAL7015





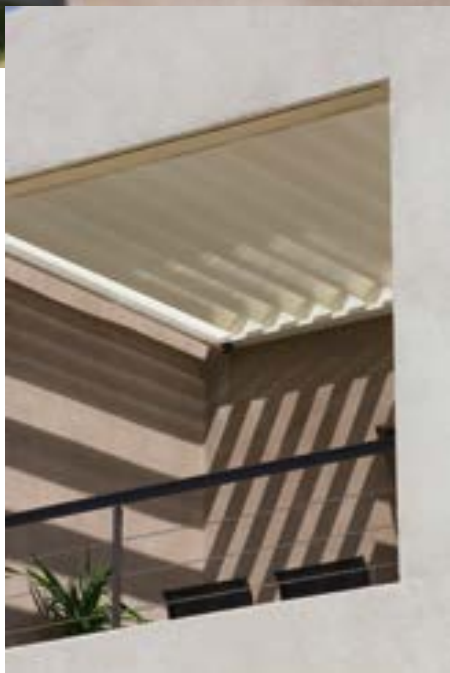

Algarve®
Frame & blades RAL 9001

STAY OUT LONGER ON YOUR
PATIO, DECK OR TERRACE



Aero®
Frame & blades RAL 9010



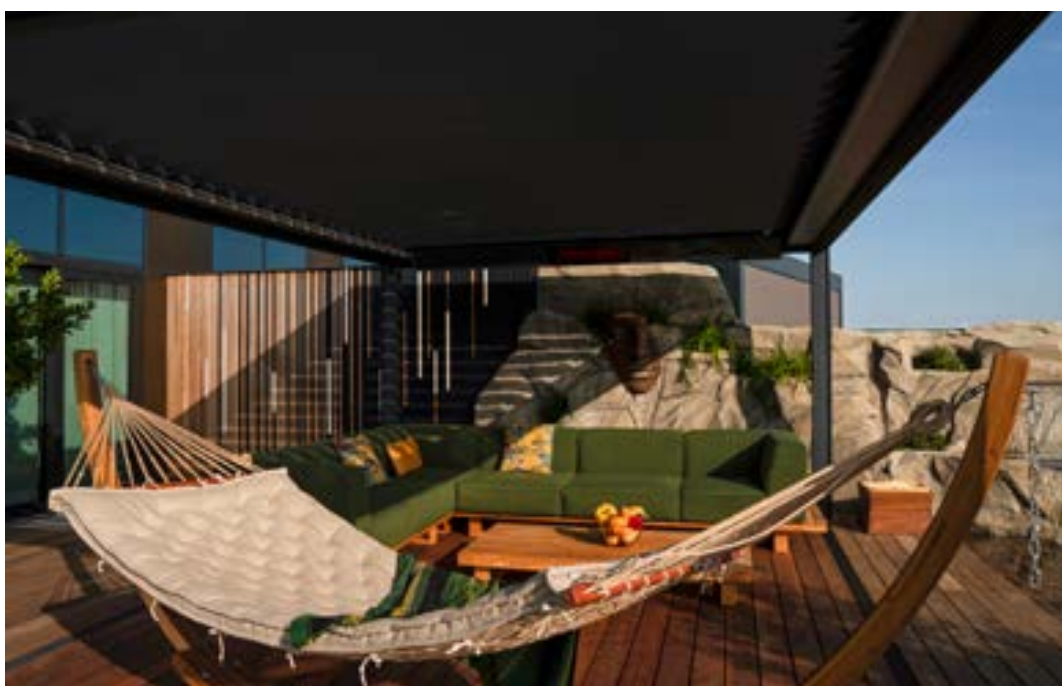
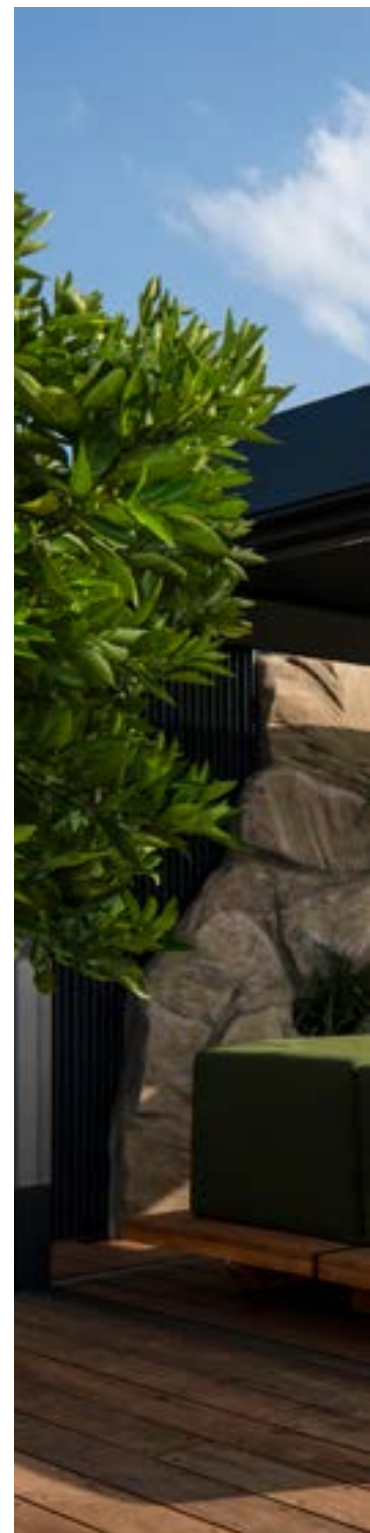

Camargue® Skye
Frame & blades RAL 8022
Linarte RAL 8022





Camargue®
Frame & blades: RAL9003

AN URBAN TERRACE IS
TRANSFORMED INTO
EXTRA LIVING SPACE





INTRO | DESIGN STYLES | PERGOLAS | APPLICATION | CUSTOMIZATION | CARPENTS | GARDEN ELEMENTS | COMPLETE CONCEPTS | FAQ | TECHNICAL INFORMATION



ALSO IN A CLASSIC STYLE

Algarve® Classic Line
Frame: RAL1019
Blades: wooddesign natural oak
*Loggiolu Privacy Wooddesign Natu-
ral Oak*





Aero® Skye
Frame & blades RAL 7035



LUXURY
CITY LIVING





AN ATTACHED STORAGE ROOM PERFECT COMFORT

Thanks to our attached storage room, I can easily store the cushions from my seats when we aren't using them. This keeps them looking as good as new and means that they don't fade.





It is easy to create storage space next to your cover by joining an Algarve bladed roof to an Algarve Canvas with fixed roof. It's a quick and easy way to store things you need on your patio to protect them from the effects of the weather.

The doors are 'Loggiascreen Canvas' sliding panels, filled with a weather-resistant fabric covering.

The outer walls can be filled with a material of your choice. The structure supplied by your ambassador dealer can be fitted with a wide range of solutions. In the Linus version, an aluminum wall insert from Renson® is in the same color as the cover where horizontal lines were used.







Heating and music

Zipshade®

Lighting

Camargue®
Frame & blades RAL 7021
Zipshade Sergé SC0130
Loggiawood Privacy WRC



CUSTOMIZATION

It was fantastic to have so many options to choose from for my pool cover. Just about any color was possible so I went with the color of our windows.

The Loggiawood sliding panels, featuring warm wood blades, to the mix have created a warm and welcoming ambience.

We are genuinely delighted. It's the perfect spot to unwind in the evening. We close the blades to keep out the chilly air out and turn on the heating. What a treat! There's no place like outside...

LIGHTING

By selecting the right lighting, you can enhance your enjoyment of your pergola.

The following options are available:

- Functional lighting (Lineo LED, Down LED, Lapure LED)
- Ambient lighting (Up LED)
- Accent lighting (Colomno LED, Up LED)

These high-quality outdoor lighting solutions are available in warm white or pure white. What's more, Up LED ambient lighting is also available in RGB, allowing you to adjust the colors to create whatever ambience suits your mood.

All lighting is dimmable.



COLOMNO LED

Integrated accent lighting on the inner side of the Camargue Line columns help showcase the architecture. Colomno LED combines beautifully with Down LED.



UPDOWN LED

Integrated LED lighting on the inner side of the frame. Fitted with lighting running upwards and/or downwards. This lets you create indirect or direct atmospheric lighting with the Camargue Line, Algarve Line, and Aero Line.

New: an all-round version is now possible

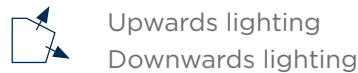

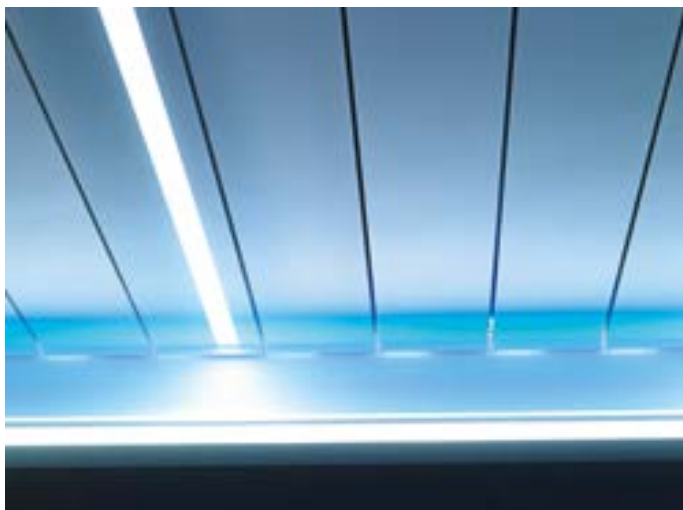

LINEO LED

LED lighting integrated into the Camargue, Algarve, and Aero blades. Extremely high light output with even distribution without visible bright spots thanks to high-quality LEDs (180 per 40").



LAPURE® LED

LED lighting integrated into the Lapure cross-beam. Extremely high light output with even distribution without visible bright spots thanks to high-quality LEDs (180 per 40").

	Warm white light	Pure white light	RGB (color) *non-UL	Dimmable
Lineo® LED Light*	✓	✓		✓
Colomno LED Light**	✓	✓		✓
UpDown LED Light** Upwards	✓	✓	✓	✓
UpDown LED Light** Downwards	✓	✓		✓
Lapure® LED Light*	✓	✓		✓

* Warm white: 1660 lm/40" (180 LEDs/40") / Pure white: 1660 lm/40" (180 LEDs/40")

** Warm white: 550-680 lm/40" (120 LEDs/40") / Pure white: 550-680 lm/40" (120 LEDs/40") / RGB: 550-700 lm/40" (60 LEDs/40")

HEATING AND MUSIC

*NON-UL

With the Heat & Sound Beam, you can enjoy your favourite tunes or benefit from the functional heating from early in the morning until late into the night.

The aluminum module extends the full width of the roof and is powder coated in the same color as your cover. Both the speaker and heating elements have been seamlessly integrated to give this option an especially sleek appearance.

What's more, you can rotate the beam up to 30 degrees to achieve the perfect heat distribution.

The combination of audio and heating guarantees a sensational total experience, but having the elements installed separately is also possible. All wiring has been invisibly concealed within the cover's structure.



Integrated heating elements and loudspeakers

The heating in your pergola is based on short-wave infrared (2400 W), which provides instant heat distribution and a safe, cosy feel.

At the same time, the waterproof sound system creates a cheerful ambience beneath your pergola. It can be connected to a multi-room system but control via a Bluetooth amplifier is also possible.



LINEO® HEAT

*NON-UL



New to the range and unique on the market is the fixed blade with seamlessly integrated IR heating. Equipped with 2 short-wave infrared 700 W lamps.

You will enjoy immediate heat distribution and a pleasant radiating warmth.

You can choose between versions with 1 or 2 heating elements per blade (1400/2800 W).

If you would like several Lineo Heat blades in your cover, they should ideally be placed 59" apart.

The ceramic glass is available in white or black.

IP class 54.

LINEO® FIX

Renson pergolas are characterised by their huge range of Customization possibilities. Lineo Fix offers you the possibility to give your own creativity free rein.

This fixed blade can be used to mount your own light fixtures, a fan, projector, or any other additional accessories.

The design makes it possible to secure weights of up to 27.5 lbs so that when the roof is closed it remains a smooth, aesthetically perfect surface.

Electrical cables can also be concealed invisibly within the Lineo Fix.





LINEO® LUCE

Camargue roofs installed with Lineo Luce's translucent blades let natural daylight in – even when the bladed roof is closed.

The translucent blades are made of high-quality safety glass, and integrate flawlessly in your pergola's bladed roof.

To ensure the cover features the preferred amount of translucence, one to five translucent blades can be integrated per roof section. These blades can be configured next to each other or be staggered between the other blades. That way you get the most enjoyment from natural daylight under your pergola.

With a cover built onto your home, you don't lose out on natural daylight indoors, even with the bladed roof closed.

TRANSLUCENT BLADES FOR CAMARGUE®

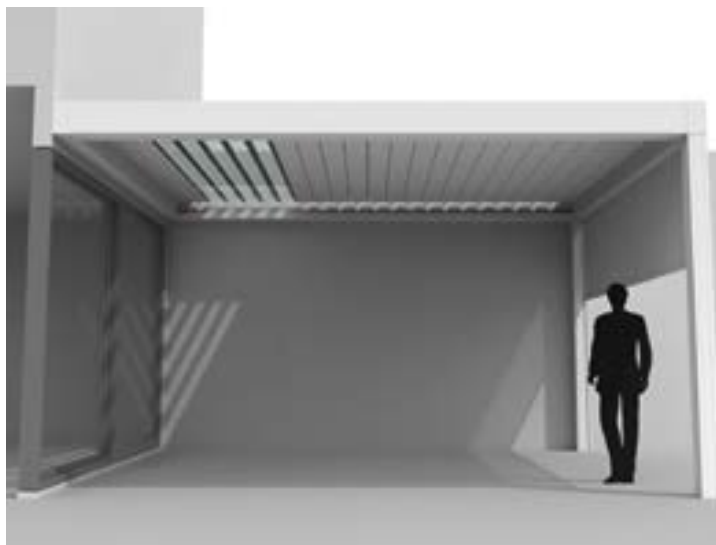

Light can enter your home, even when the roof is closed

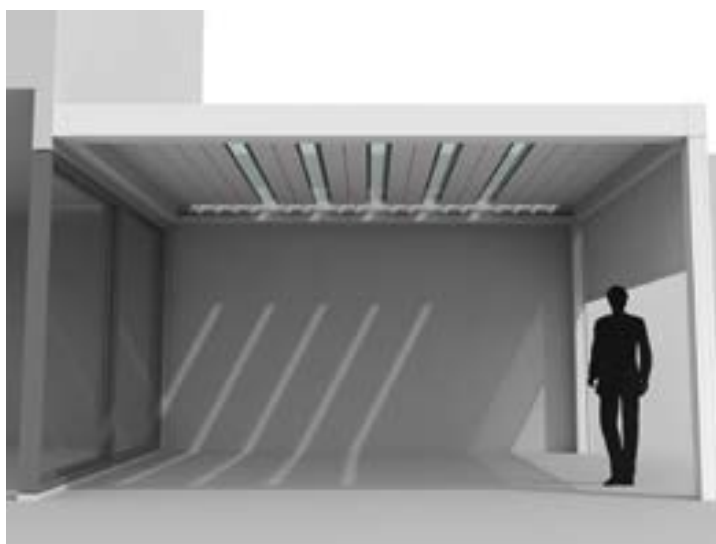

Light under the pergola with roof closed

PROTECTO

PROTECTION PROFILE BETWEEN BLADES AND GUTTER FOR CAMARGUE®, ALGARVE® AND AERO®



- This profile provides protection against any wind, rain and snow that may get between the blades and frame to enter the cover.
- When opening and closing the blades, the protecto profile automatically maintains contact with the blades, thanks to an invisible hinge system.
- Powder coated in the same color as the frame and columns.
- It is possible to reorder covers that have already been installed (Algarve from 2018 and Camargue from 2015).

LOGGIA®

Loggia sliding panels offer infinite possibilities.

In addition to the unique, customized look they lend your cover, they also offer the following benefits:

- sun protection
- wind protection
- privacy
- protection

The fixed aluminum frame of the sliding panels can be installed with blades or canvas fabric. The sliding system is supported by a bottom rail that accommodates small height differences up to 1.96 inch thanks to the patented Flexguide.

Loggia sliding panels can be installed with Camargue, Camargue Skye, Algarve* and Algarve Canvas.

* Not available for Algarve made in the US

SLIDING PANELS

FOR CAMARGUE® LINE AND ALGARVE® LINE*

TYPES

- Loggiawood: wooden blades (Western Red Cedar or Thermo-es)*
- Loggiawood Privacy: rotating wooden blades (Western Red Cedar or Thermo-es)*
- Loggiascreen Canvas: screen fabric (fiberglass) + Mixtrim*
- Loggialu: aluminum blades
- Loggialu Privacy: rotating aluminum blades
- Loggialu wooddesign: aluminum blades with wooddesign*

INTEGRATION

Camargue Line: possible in Span and/or Pivot

Algarve Line: possible in Span and/or Pivot up to 177 in*

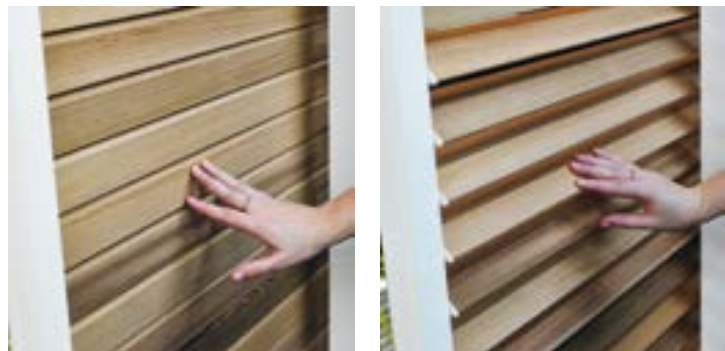

PRIVACY

Manually adjustable wooden or aluminum blades. The Privacy version of the Loggiawood and Loggialu sliding panels have blades that can be rotated manually to a fully open or closed position.



* Not available for Algarve made in the US

UNIQUE: LOGGIA SLIDING PANELS AND ROOF BLADES IN THE SAME WOODDESIGN

WOODDESIGN

Camargue Line fitted with aluminum roof blades in wooddesign

- Natural appearance of wood combined with the advantages of aluminum in terms of:
 - Easy to maintain
 - Colorfast
 - Maintains its shape
- Also available for LED blades
- Combines perfectly with the Loggialu Wooddesign sliding panels
- Roof blade in wooddesign (frame and columns have standard coating)
- Available in 3 types:
 - White oak
 - Natural oak
 - Walnut



White oak



Natural oak



Walnut

OUTDOOR CURTAINS

Both the Camargue Line and Algarve* Lines can be fitted with outdoor curtains. This allows you to create a fairy-tale atmosphere under your pergola.

These polyester curtains for outdoor use are water-repellent, mold-resistant, and dirt-resistant. They are also weather-resistant and color-fast, even after washing. The curtains are completely wrinkle-free and can be made to measure. Moreover, they can be combined with glass sliding panels and integrated Zipshades in the Camargue Line. The outdoor curtains can be fitted in combination with UpDown lighting. This gives the pergola a romantic feel at twilight

* Not available for Algarve made in the US.

EARTH OASIS

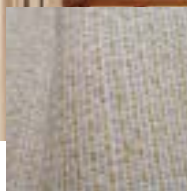

*Thick woven
Savannah
Yellow*

PURE ESSENCE



*Refined woven
White Corn*

IDYLIC GARDEN

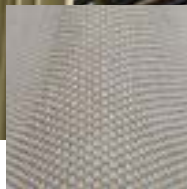

*Refined woven
Planton*

SPIRITUAL HARMONY

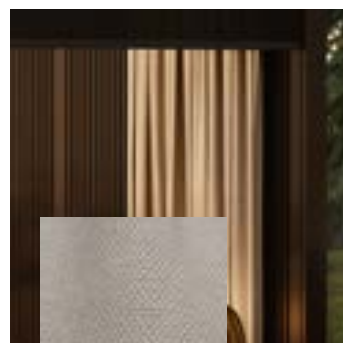

*Refined woven
Beige Brown*

TECH COCOON



*Fine woven
Ecru*

CRYSTAL LOUNGE



*Fine woven
JadeitePlanton*

TRANSPARENT SLIDING WALLS FOR CAMARGUE® LINE AND ALGARVE® LINE



The Camargue Line is fitted with glass sliding panels and integrated Zipshades in the Span and Pivot side

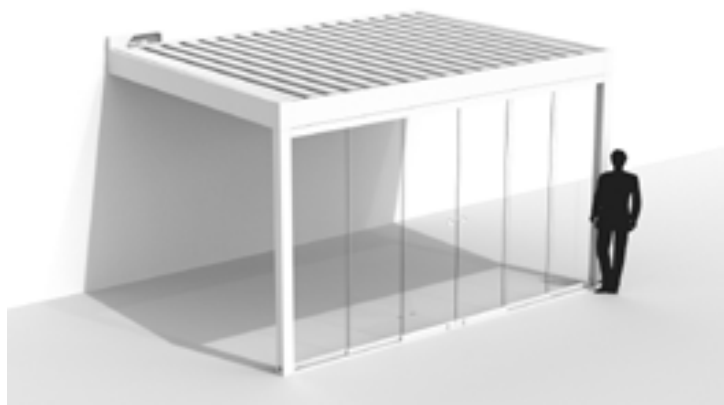

The Algarve Line is fitted with a glass sliding panel in the Pivot

GLASS SLIDING PANELS

You can also choose to install glass sliding panels. These fully transparent sliding panels accentuate the elegance of both the Camargue and Algarve Lines. They also protect you from the weather and wind, and the pergola can be completely enclosed to prevent theft. You can, of course, always integrate vertical, windproof Zipshade sun protection with a glass sliding panel to maintain the major benefit of sun protection.

Plus, you can combine the glass wall with outdoor curtains, together with integrated Zipshades. Made in Belgium.

INTEGRATION

Camargue Line & Algarve Line: possible in Span and/or Pivot

DISTRIBUTION OF GLASS SLIDING PANELS			
59 in. \leq X \leq 98 3/7 in. Width X	98 3/7 in. $<$ X \leq 147 2/3 in. Width X	147 3/7 in. $<$ X \leq 206 2/3 in. Width X	206 2/3 in. $<$ X \leq 256 in. Width X
3 panels	4 panels	6 panels	8 panels
3 rails	4 rails	3 rails	4 rails
Opens to the left or opens to the right	Opens to the left or opens to the right	Opens to the left and opens to the right	Opens to the left and opens to the right
Incl. 1 handle	Incl. 1 handle	Incl. 2 handles	Incl. 2 handles

LINIUS® & LINARTE®

The Linius or Linarte bladed wall lets you create a physical barrier or a decorative finishing for the rear wall. The fixed wall is available as a single or a double-sided, clad-ded wall across the entire passage height, or can be finished at a customized height with a top profile to create a railing. Ideal as a border for patios in the hotels, restaurant, and catering sector. The Linarte fixed wall is always installed with tautly stretched screen fabric on one side.

The support structure ensures that the connection between the finishing blades is not visible, which creates an unbroken line along the entire width. The wall fits neatly into the space in the columns on both the front and back sides. Height differences in the floor up to 2.36 in. are compensated by the finishing plinth, so that no annoying openings are visible at the bottom. The wall is custom-finished in the color of the pergola or one of your choosing. Moreover, the double-sided wall allows for the application of sound proofing. This way, you can enjoy the nature around your pergola in peace and quiet.

*For Algarve available as back-order Made in Belgium.

FIXED WALL

**LINIUS FOR CAMARGUE® LINE AND ALGARVE® LINE &
LINARTE FOR CAMARGUE® LINE***



Linus®



Linarte®

LOGGIA® EASY PASSAGE

EASY PASSAGE / SLIDING DOOR FOR CAMARGUE® LINE AND LAPURE®



Camargue fitted with an integrated Zipshade and sliding door using a Loggiascreen Canvas in the Span side

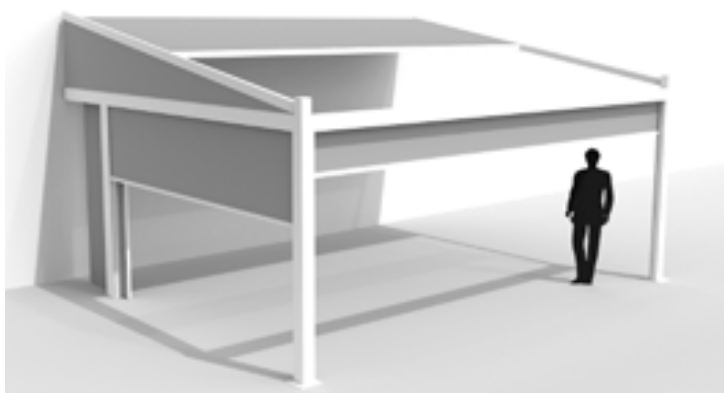

Lapure fitted with a Zipshade and sliding door using Loggiascreen Canvas in the side

INTEGRATION

Camargue Line: possible in Span and/or Pivot

Lapure: available in side or front

Width: min. 31 1/2 - max. 47 1/4

Ideal if the pergola is completely enclosed (e.g. by Zipshade) and you want to quickly get to or from the pergola without having to open the Zipshade (no loss of comfort for those sitting under the pergola).

The easy passage consists of an aluminum frame covered on one side with a fiberglass screen fabric of your choice.

INTEGRATED ZIP-SHADE®

Thanks to an **ingenious zip system**, the fabric is windproof in every position and the screen is insect-proof when closed. It is an incredibly well-thought-out principle in which the sun protection fabric has a special zipped trim. This ensures that the entire structure is held firmly in place by the two side guiding channels. By integrating this Zipshade, with or without Crystal windows to keep a view of the outside, you can create an extra outdoor room where users are protected from sun, rain, and wind. Available in more than 50 colors, these screens allow you to personalize the Camargue Line to create the atmosphere you want.

SUN PROTECTION FABRIC FOR THE CAMARGUE® LINE

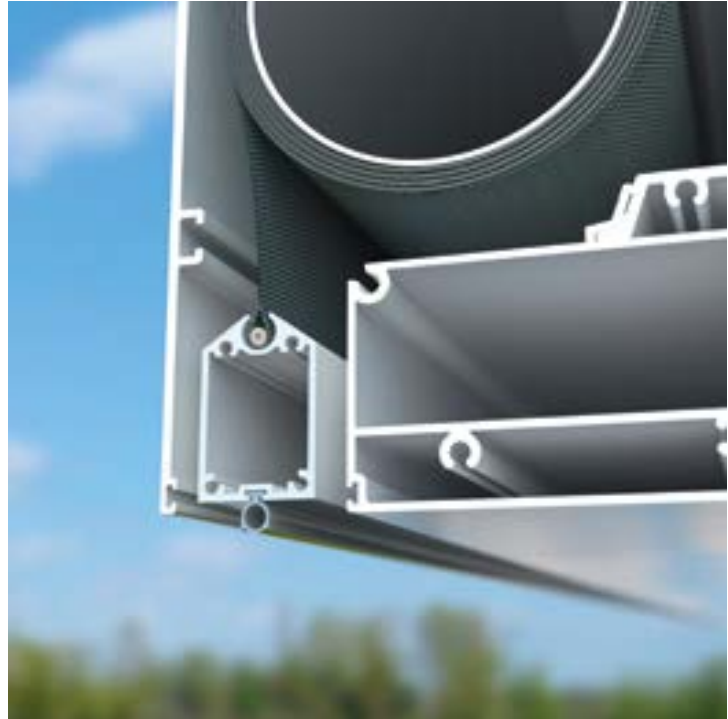

Bottom bar disappears into the head box

PERFECT INTEGRATION, EVEN AFTERWARDS!

Ideal for:

- Privacy
- Shadow when the sun is low in the sky
- Protection from wind, rain, and insects

BOTTOM BAR DISAPPEARS INTO THE HEAD BOX

The Camargue Line's frame profiles are developed in such a way that the bottom bar is aesthetically hidden away in the head box when the screen is raised. Perfect integration, even afterwards!

SURFACE-MOUNTED ZIPSHADE®

To close the sides of Algarve or Lapure, it is possible to combine them with a Zipshade base. This allows for the sun protection head box to be installed underneath the frame profiles so that this connects perfectly with the basic construction.

SUN PROTECTION FABRIC FOR THE ALGARVE® LINE AND LAPURE®



TIP

CUSTOMISED PRINT

In addition to our standard range, fabrics can also be customised. Options include printing your business logo or a photo onto a screen underneath a pergola.



CRYSTAL FABRIC

Transparent crystal fabric can be placed in the fiberglass fabric of the Zipshade to maintain optimal contact with the outdoors. This transparent type of fabric consists of PVC (Fire classification M2). This transparent crystal fabric can be integrated into a fiberglass fabric with a Zipshade base and integrated Zipshade® during installation.

The Crystal fabric is always 47'1/4" in high and extends across the full width of the Zipshade. A minimum distance of 47'1/4" in applies between the Crystal fabric and the top and bottom border of the Zipshade.

OPTIMUM CONTACT WITH THE OUTDOOR SPACE

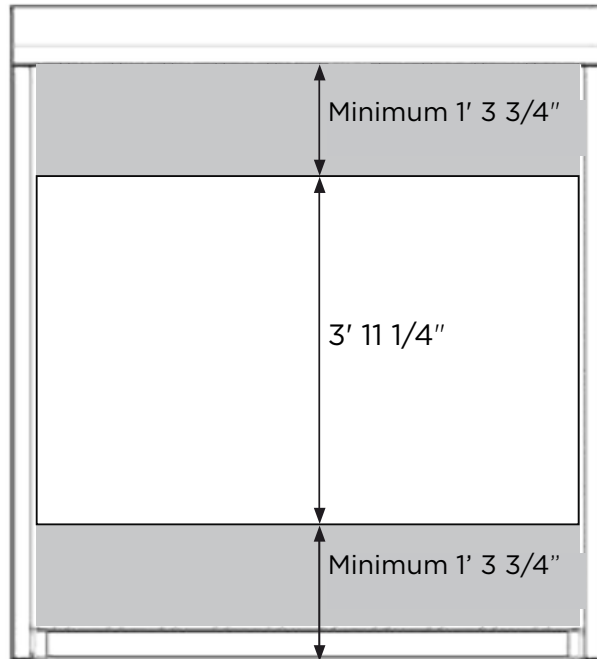

TIP

A distance of 31" to 39" from the bottom side provides the best possible view for people underneath the pergola.

FIBERGLASS FABRICS

TRANSPARENT SUN PROTECTION FABRIC CAMARGUE® LINE, ALGARVE® LINE AND LAPURE®



Fiberglass fabric is the best translucent sun protection fabric for windproof vertical sun protection. Fiberglass fabrics score the highest in terms of tension and rigidity, and are also highly resistant to moisture and heat, while maintaining a great outdoor view. We offer a wide range of colors so that you can find the fabric that suits you perfectly. The Architects' Selection is a color collection that is very popular in current design and architecture trends. Our Renson® Ambassadors are happy to help you choose. Fiberglass fabrics are also available with a Crystal window, providing a crystal-clear view.

FABRIC TYPES

Zipshade fabrics are available in 50 colors and three different woven patterns.



Sergé

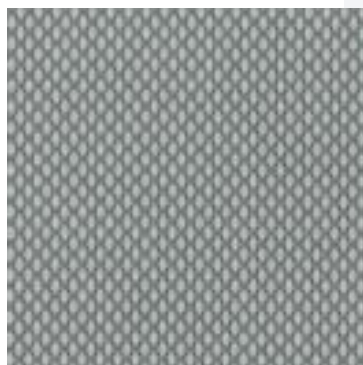

Natté



Privacy

WATERPROOF SCREEN FABRIC FOR LAPURE®

Lapure's roof is fitted with an innovative, waterproof, transparent sun protection fabric. Both sides of this polyester fabric are coated with UV-resistant, waterproof coating. This fabric is available in a range of colors.

SOLTIS® PROOF W96



W96-1103



W96-8102



W96-2171

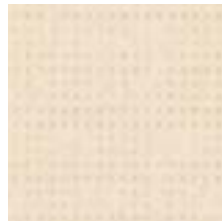

W96-8861



W96-2047

SWK TOP WATERPROOF

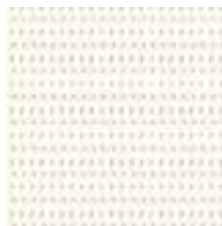

M005 White



M006 Pearl



M652 Silver

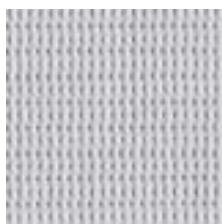

M654 Grey



M712 Beige



M939 Elephant

CANVAS FIBERGLASS FABRICS

The roof of Algarve Canvas and Aero Canvas is finished with a unique patented tension ceiling. Fiberglass fabric is stretched into the frame using the proven Zip-shade technology. This gives the ceiling a horizontal, seamless and clean finish without any annoying intermediate beams.

TENSION CEILING FOR ALGARVE® CANVAS & AERO® CANVAS

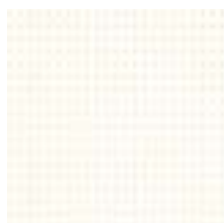

0202 White



0220 White Linen

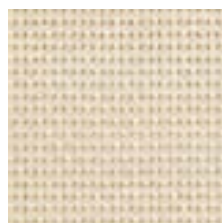

2020 Linen



0720 Pearl Linen



0207 White Pearl



0707 Pearl



3001 Charcoal Grey

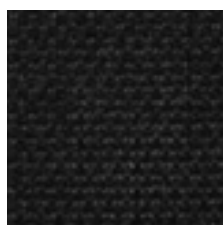

3030 Charcoal



COLOR SELECTION ALUMINUM

AVAILABLE IN OVER 100 TEXTURED COATING COLORS

Our pergolas are powder coated with 'Seaside quality' pretreatment as standard. The products are available in over 100 RAL colors in textured coating at no extra cost.

Renson® recommends using textured coatings to achieve an architectural, contemporary look. In addition, textured coatings are more suitable for outdoor use and will hide any scratches much better.



TIP

The columns' smart design makes it possible to integrate a plug socket or other technology suitable for outdoor use.



AUTOMATION



EASY REMOTE CONTROL

Somfy automation makes operating your pergola easy. You can operate the roof and/or the screens of your pergola by remote control. Depending on the desired use and the number of screens, you can choose from several different remote controls.

Thanks to the Renson Connect app, you can control your pergola using your smartphone or tablet. However, a Tahoma box/switch is required for this.

We recommend installing rain and/or wind sensors for optimum comfort.

SMART CONTROL OF YOUR PERGOLA USING THE RENSON CONNECT APP

The Renson Connect app is a must for the smart control of your pergola from your smartphone or tablet. It can be used for a range of electrical pergolas and carports, such as Camargue Skye. This makes it easy to operate your pergola's bladed roof, screens, LED lighting and heating, even from a distance.

The Renson Connect app can be downloaded free of charge and is easy to configure. It can be used in combination with all radio-controlled Renson pergolas (Somfy io and RTS compatible). You will also need a Somfy Tahoma Smart home hub in your home.

This smart io-homecontrol communication technology immediately shows the status of your various components (blades, screen, lighting, heating) in the app.

It's ideal if you need to control your pergola from a distance. The communication between your systems is encrypted and therefore extremely safe!

Naturally, you can also control your pergola using a simple remote control.









CARPORTS

We were looking for a pergola with a bladed roof and a carport in the same style to match our newly built home. We found the ideal solution with Algarve and Algarve Canvas from the Algarve Line. The elegant structure fits in beautifully with our sleek architecture and meets our needs perfectly.

Our car can now be parked under the shelter of an Algarve Canvas and the value of our home has increased considerably. We used Algarve to create the ideal climate on our patio and we have a structural solution that protects us from the sun, rain, wind, and cold thanks to the adjustable, bladed roof, the sun protection screens, and the stylish heating system.



ALGARVE® CANVAS

This elegant carport offers lasting protection by means of a fixed roof made up of 2 layers: a solid top roof made of white or anthracite powder coated, profiled steel sheet with anti-condensation coating and an aesthetic lower roof, finished with a stretched fabric with zip technology.

The fabric is tautly stretched in the structure, without any visible additional beams. It is available in 8 colors. Algarve Canvas is just as useful as a fixed pergola, carport, or as an awning above the front door, for instance. In addition, the combination of an Algarve with rotatable bladed roof and an Algarve Canvas with fixed roof structure makes it possible to create a single, uniform style around your house.



Algarve® Canvas
Frame & blades RAL 9005
Canvas Charcoal

INTRO | DESIGN STYLES | PERGOLAS - APPLICATION | CUSTOMIZATION | CARPORTS | GARDEN ELEMENTS | COMPLETE CONCEPTS | FAQ | TECHNICAL INFORMATION





ALGARVE® CANVAS EXTENSION WITH STORAGE



*Example of an extension in length:
23 ft x 11 1/2 ft*



*Example of an extension in width:
16 ft x 18 ft*



Algarve® Canvas
*Frame & blades RAL 9005
Canvas Charcoal*





Algarve® Canvas
Frame & blades RAL 7006
Pearl Linen Canvas
Linus RAL 7006



ONE STYLE SURROUNDING YOUR HOME



Algarve® Canvas
Frame & blades RAL 7006
Pearl Linen Canvas
Linus RAL 7006





GARDEN ELEMENTS

Thanks to our complete Outdoor Concept, not only can you extend the minimalist design of the Linarte façade cladding to your pergola, but you can also create a unique look throughout your garden with Linarte lighting, Sit & Plant Units, and the freestanding Icon wall.



Garden elements
RAL 9005





LINARTE® OUTDOOR LIGHT

Linarte Outdoor Light is available in Renson standard textured coating colors.

The lighting is not dimmable.
Linarte Even is available in two heights with different options:

LINARTE OUTDOOR LIGHT SMALL



Single plug socket



Single lamp



Double lamp Front & rear



Lamp with plug socket

Height 12"
Depth 4"
Width 3"



LINARTE OUTDOOR LIGHT MEDIUM



Single plug socket



Single lamp



Double lamp Front & rear



Lamp with plug socket

Height 20"
Depth 4"
Width 3"

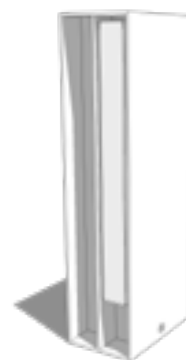

LINARTE® MODULO SYSTEM

Linarte Block 30 & Linarte Even models. Seating element or planter border in thermo-es. Optional with indirect lighting at the bottom or direct lighting with LED modules. Available in Renson standard textured coating colors.

OVERVIEW



Linarte Modulo 55 SIT



Linarte Modulo 55 PLANT

Height	17"
Length	21"
Width	21"



Linarte Modulo 97 SIT

Height 17"
Length 38"
Width 21"



Linarte Modulo 97 PLANT



Linarte Modulo COMBINATION

Height 17"
Length adjustable
Width 21"

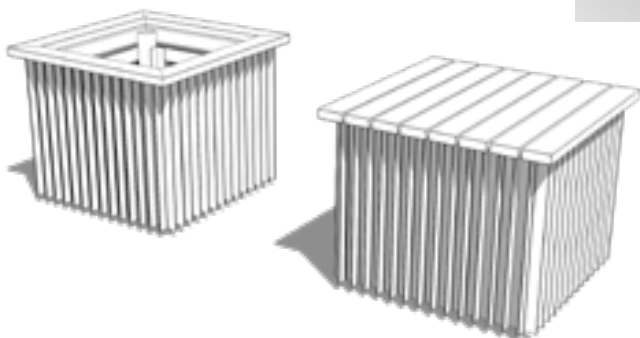

LINARTE ICON

FREESTANDING WALL

Linarte Icon adds an extra dimension to the garden. This architectural wall is available in a height and width according to your wishes, so the possibilities are endless: from a low garden wall, to a privacy wall, to spacial dividers that visually expand the garden.

The vertical Linarte lines with Block 30 or Even blades form a seamless whole over the entire wall. In addition, one of the two sides can also be fitted with a stretched fiberglass fabric of your choice, which brings the warm feeling of textiles into the outdoor space. Material and color can be matched to the outdoor furniture if required. You can create even more atmosphere by adding Linarte LEDs or wood inserts or by integrating an indirect lighting at the bottom of the wall that spreads a beautiful glow. Powder coated in any color of your choice, the Linarte Icon in combination with the Linarte façade elements, seating elements, lighting, and Linarte wall in Camargue form one coherent all around the house and throughout the garden.

SLEEK DESIGN

- Create a uniform look and feel with your façade cladding throughout your garden with the Renson Outdoor Concept range.

CUSTOMISABLE

- Combination of Linarte profiles, canvas fabric, or single-sided finishing.
- RAL color of your choice.
- Inserts with thermo-es or LED module.
- Indirect lighting.



DURABLE QUALITY

- Posts in 9/64"-thick steel
- Finishing in high-quality aluminum, weatherproof and recyclable.

MAINTENANCE-FRIENDLY

- Colorfast, easy to clean.

DIMENSIONS

- Width: min. 50"
- Height: min. 15 3/4" - max 78"
- Thickness: min. 6" - max. 7"
- Distance between 2 support posts: max. 47"
- Depth for concrete: 29"

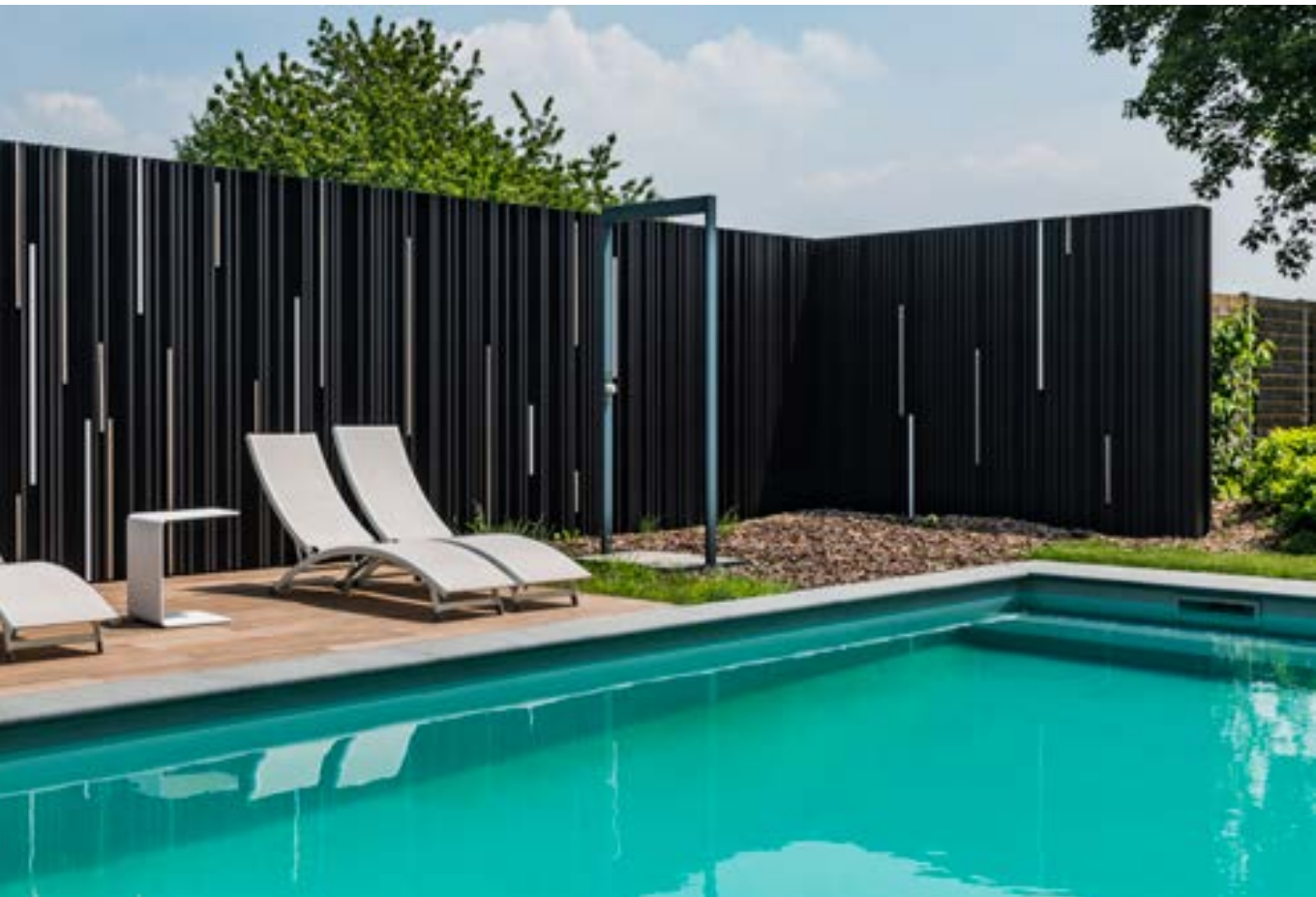





ESAFE PACKAGE DROP MAILBOXES

A driveway is invariably the calling card of a house & front yard! Choosing the right style and materials will give your driveway the same look as your dream home.

A design package drop mailbox adds the finishing touch & **from now on, you will receive all your packages safely at home 24/7.** That's so much easier!

- Sleek design
- Available in all RAL colors
- Strong, quality powder-coating
- Stainless aluminum
- Personalization & integration (number, name, color, digital lock, doorbell, video-phone)
- Made in Belgium

Discover the full eSafe range of package drop mailboxes at www.my-esafe.be



FENIX TOP SMALL

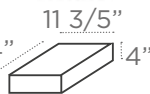

FENIX TOP MEDIUM



FENIX TOP LARGE

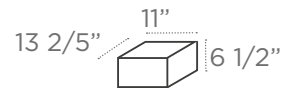

Package dimensions:



CONCEPTS



- ① Aero® pergola - page 94
- ② Algarve® Canvas carport - page 161
- ③ Linius® façade element - page 148
- ④ Linarte® Outdoor Light S - page 174



- ① Linarte® façade element with LED lighting – page 148
- ② Linarte® ICON freestanding wall with LED lighting – page 178
- ③ Linarte® ICON freestanding wall with wood inserts – page 178
- ④ eSafe® package drop mailbox – page 181
- ⑤ Loggiawood® Linea sliding panels – page 144
- ⑥ Linarte® façade and gate cladding – page 148
- ⑦ Linarte® Outdoor Light S – page 174



- ① Aero® Canvas roof element - page 76
- ② Linarte® façade element with LED lighting and wood inserts - page 148
- ③ Aero® Canvas roof element - page 161
- ④ Linarte® Modulo 97 PLANT - page 176
- ⑤ Linarte® Modulo 97 SIT - page 176
- ⑥ Linarte® Outdoor Light M - page 174





- ① Algarve® Canvas Classic Line carport - page 160
- ② Linarte® Modulo combination PLANT - page 176
- ③ eSafe® Package drop mailbox - page 181



- ① Camargue® joined pergolas - page 30
- ② Camargue® Skye pergola - page 30
- ③ Linarte® Outdoor Light M - page 174
- ④ Linarte® Modulo 97 PLANT - page 176
- ⑤ Linarte® Modulo 97 SIT - page 176
- ⑥ Loggia® sliding panels - page 144
- ⑦ Linarte® custom - page 148





- ① Algarve® 'Classic line' joined pergolas – page 76
- ② Linarte® Modulo 55 PLANT – page 176
- ③ Linarte® Outdoor Light S – page 176
- ④ Algarve® 'Classic line' Canvas joined carport – page 161
- ⑤ Linius wall – page 148
- ⑥ Linius® Modulo 97 PLANT – page 176





- ① Algarve® roof element - page 76
- ② Linarte® façade element with LED lighting and wood inserts - page 148
- ③ Algarve® roof element - page 76
- ④ Linarte® Modulo 55 PLANT - page 176
- ⑤ Linarte® wall - page 148
- ⑥ Linarte® Outdoor Light M - page 174
- ⑦ Linarte® MODULO combination - page 176
- ⑧ Aero® roof element - page 94





- ① Algarve® roof element - page 76
- ② Linius® façade element with LED lighting - page 148
- ③ Camargue® roof element - page 30
- ④ Side element Zipshade® sun protection fabric - page 150
- ⑤ Linarte® Modulo combination PLANT - page 176
- ⑥ Zipshade sun protection fabric
- ⑦ Linarte® Modulo 97 PLANT - page 176
- ⑧ Linarte® Modulo 55 & 97 SIT - page 176
- ⑨ Linarte® Outdoor Light M - page 174





- ① Camargue® roof element - page 30
- ② Linarte® façade element - page 148
- ③ Aero® Canvas roof element - page 94
- ④ Algarve® roof element - page 76
- ⑤ Linarte® modulo combination - page 148
- ⑥ Linarte® ICON - page 178
- ⑦ Linarte® Outdoor Light M - page 174





3

4

6

5

- ① Algarve® roof element - page 76
- ② Linius® façade element - page 148
- ③ Side element Zipshade® sun protection fabric - page 150
- ④ Linarte® Modulo 55 SIT - page 176
- ⑤ Linius wall - page 148







Algarve® & Algarve® Canvas
Frame & blades RAL 7006
Pearl Linen Canvas
Zipshade Sergé SC3231



FAQ



WEATHER-RESISTANT

CAN BE CLOSED TO BLOCK OUT RAIN AND WIND

Camargue Line, Algarve, and Aero Line are pergolas with rotating blades in the roof. These patented blades are designed in such a way that the water is drained off to the side even if the blades open up after it rains.

Lapure is a pergola with waterproof, translucent sun protection fabric. Zipshade technology combined with optimum screen tension ensures that rainwater drains from the fabric via hidden channels. Even if the sun protection fabric is not fully unrolled, the water that falls on it is drained away via this integrated water drainage system.



The Camargue Line can drain an amount of water equivalent to a rainfall intensity of 0.66 GPM for up to two minutes max. This type of rainfall occurs on average once every 15 years in Belgium (cf. Belgian rain statistics: standard NBN B 52-011).

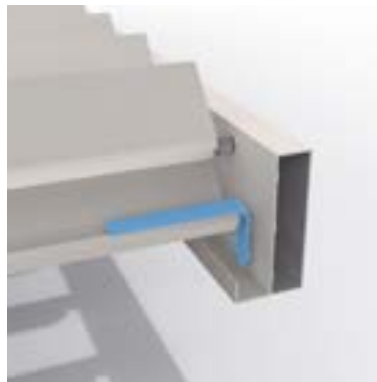

The Algarve Line can drain an amount of water equivalent to a rainfall intensity of between 0.53 GPM and 0.66 GPM for up to two minutes max. This type of rainfall occurs on average once every 10 years in Belgium (cf. Belgian rain statistics: NBN B 52-011 standard).

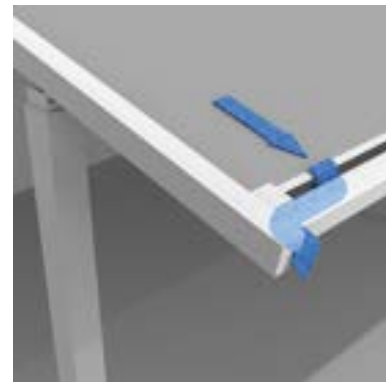

The Lapure can handle a rainfall intensity of 0.22 GPM for up to two minutes max. In heavy rainfall, water can flow over the bottom bar. Extreme rainfall can cause water sagging. If this happens, the fabric must still be rolled up.

TESTS

PROTECTION AND COMFORT

Our pergolas offer protection and comfort at various levels. To guarantee they can do so, they are thoroughly tested for water drainage, load-bearing capacity and wind resistance.

WATER TESTS

Water repellence and water drainage are tested using a spray installation that mimics rain. For example, we check the how much airflow our pergolas can extract and how this drainage can be optimised:

- Algarve Line: The Algarve Line can drain an amount of water equivalent to a rainfall intensity of 26 gal/yd²h for up to two minutes max. This type of rainfall occurs on average once every 10 years in Belgium (cf. Belgian rain statistics: NBN B 52-011 standard).
- Camargue and Camargue Skye: The Camargue and Camargue Skye can drain an amount of water equivalent to rains with an intensity of 33 gal/yd²h that lasts up to 2 minutes maximum. This type of rainfall occurs on average once every 15 years in Belgium (cf. Belgian rain statistics: NBN B 52-011 standard).
- Lapure: The Lapure can maintain a precipitation rate intensity of 11 gal/yd²h for up to two minutes max. In heavy rainfall, water can flow over the bottom bar.

LOAD-BEARING CAPACITY

Pergolas are subjected to various external forces (e.g. snow). The load-bearing capacity of our pergolas is determined using static strength calculations carried out by our engineers and validated through in-house testing. The basic principle is that the structure is allowed to bend by 1/200 of its longest dimension without any permanent deformation.

The load-bearing capacity of Algarve and Camargue is dependent on the basic structure and surface area. The diagram indicates the load-bearing capacity of our pergolas depending on their Span and Pivot dimensions.

In concrete terms: A pergola with a Pivot of 236 2/9 and a Span of 157 1/2 may bend by 1 1/6 under a load of 11.26 psf (i.e. 1920 lbs across the entire pergola). Another example: a pergola with a 132 7/8 Span and a 230 Pivot can bear a load of an impressive 20 psf (i.e. 4762 lbs!).

External testing done on the Camargue shows that it can hold up at 41 psf and remain intact, even for the largest pergola dimensions.



40.9 psf

UNIQUE RESISTANCE TO HEAVY WINDS AND STORMS – PERFECT FOR APPLICATION IN HIGH-RISE CONSTRUCTIONS



WIND TESTS

Wind tunnel tests were conducted to determine the wind forces that our pergolas and vertical sun protection fabrics can withstand.

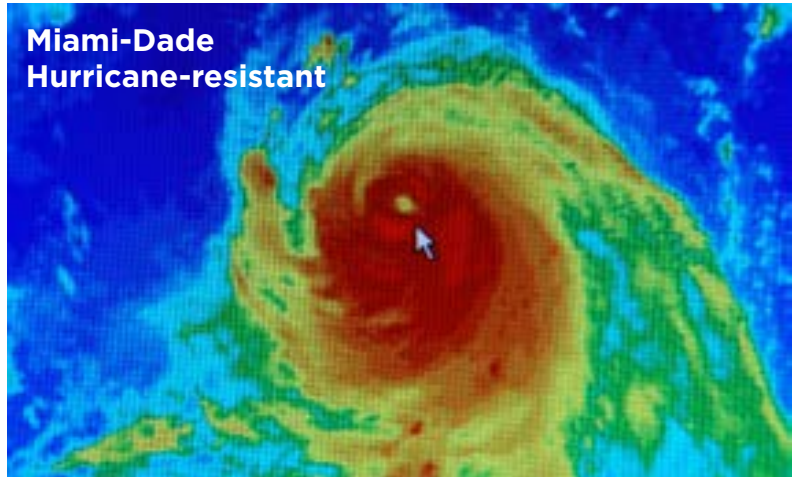

	Warranty with closed roof/screen up to	Operating roof/screen up to
Camargue® Line	99 mph 12 Beaufort	31 mph 7 Beaufort
Camargue Skye® Algarve® Line Aero® Line	74 mph 11 Beaufort	31 mph 7 Beaufort
Lapure®	62 mph/h 10 Beaufort	31 mph 7 Beaufort
Integrated Zipshade®	37 mph 7 Beaufort	18 mph 5 Beaufort
Zipshade® in sub-structure	37 mph 7 Beaufort	18 mph 5 Beaufort

BEAUFORT SCALE



Beaufort	Description	Average speed in mph	Results
0	Calm	< 0.6	You don't feel any wind. Smoke will rise virtually straight upwards.
1	Light air	0.6 - 3.1	Wind direction can be read from the smoke plume, but not from the weather vane.
2	Light breeze	3.7 - 7.5	Wind can be felt on the face, leaves rustle, the weather vane moves visibly with the wind.
3	Gentle breeze	8.1 - 11.8	Flags wave and leaves move about constantly.
4	Moderate breeze	12.4 - 16.7	Dust blown up irritates eyes. Hair is tousled.
5	Fresh breeze	17.4 - 23	Bushes rustle, white wave peaks on lakes and canals.
6	Strong breeze	23.6 - 29.8	Umbrellas are difficult to hold on to, large branches sway, power lines hum
7	High wind, moderate gale, near gale	30.4 - 38.5	It is difficult to walk into the wind. Trees sway.
8	Gale, fresh gale	39.1 - 45.4	Making headway is very difficult. Small branches break off.
9	Strong/severe gale	46 - 54	Chimney tops, roofing tiles and antennas blow away.
10	LAPURE®	54.7 - 63.4	Adults blow over. Major damage to buildings.
11	ALGARVE® LINE CAMARGUE SKYE®	64 - 72.7	Major damage to houses and forests.
12	CAMARGUE® LINE	> 73.3	Total destruction.



TESTED FOR USE IN SEISMIC AREAS

Thanks to our close cooperation with Newport Structural Design we are certified to install our pergolas in seismic areas in the states of Washington, Oregon and California.

Our Camargue MD is certified and tested up to Hurricane category 5 [157mph+] This is the highest hurricane class.

WARRANTY*

PERGOLAS	15 years	10 years	5 years	2 years
Camargue, Camargue Skye, Algarve, Algarve Canvas, Aero, Aero Skye, Aero Canvas		✓		
Lapure			✓	
Sideways inserts				
Zipshades			✓	
Crystal window in the full width				✓
Loggias			✓	
Glass sliding panels			✓	
Fixed walls (Linus, Linarte)			✓	
Outdoor curtains			✓	
Comfort				
Lighting, heating and music				✓
Lineo Luce, Lineo Fix			✓	
Protecto			✓	
Sensors				✓
Garden elements				
Linarto Icon, Modulo, Outdoor Light			✓	
SPECIAL WARRANTY PROVISIONS				
Motorisation and control			✓	
Somfy and Renson motors			✓	
Color and shine	✓*			
Coating adhesion		✓**		
Fiberglass, polyester, & acrylic fabrics			✓***	

* 5-year standard warranty / 15-year warranty subject to registration of extended warranty and annual maintenance using the Renson Maintenance Set. The extended warranty is not applicable in coastal areas and heavily polluted areas and is also not applicable to wooddesign, aluminum castings and mounting bases.

** Areas < 1,500 feet from a coastline: 5-year warranty on powder coating adhesion.

*** Wrinkling typical of polyester fabrics is not covered by the warranty.



Register your pergola within 15 days of its installation and receive



WARRANTY



WWW.RENSON-OUTDOOR.COM/WARRANTY

*A 5-year warranty applies to the color and gloss of the coating. If you register the pergola and annually clean and protect it with the Renson Maintenance Set, you will receive an extended coating warranty of up to 15 years.

MAINTENANCE

EASY MAINTENANCE WITH THE RENSON MAINTENANCE SET

Your pergola will be fully exposed to the elements for years – day in and day out. If you want to get the most out of your Renson® cover indefinitely, we recommend maintaining it regularly, i.e. once or twice a year. Regular maintenance will extend the lifespan of your pergola. The following matters are important:

- The structure is made of powder coated aluminum. An annual cleaning with Renson Maintenance Set products will ensure that the intense color is maintained for years, as well as providing extra protection from acid rain, sea air, and UV radiation. If you live in a coastal or wooded area, we recommend maintenance at least twice a year.
- Renson 'Clean' is a concentrated product with strong cleaning and degreasing properties to deal with the most frequent kinds of natural filth, such as dust, oily precipitation, grease stains, moss, insect remains, etc.
This product cannot be compared to other cleaning products on the market. It penetrates deeply and 'lifts out' the dirt. Renson 'Clean' can also be used to clean polyester roof fabrics and vertical fiberglass screen fabrics.
After cleaning, you must protect the aluminum structure with Renson 'Protect'. This leaves a protective film, so that surfaces can be cleaned by simply wiping them down with a tiny amount of Renson 'Clean'. It also protects the aluminum from acid rain, sea air, and UV radiation, and ensures that the color remains just as intense.
- Do not use either product in direct sunlight or in hot weather. The product's quick-drying action can leave stains on the structure of the fabric. Do not use corrosive or aggressive products, scouring pads or other scouring products. Do not under any circumstances use high pressure cleaning equipment on your product.

TIPS

COLUMN POSITIONS

Camargue Line, Algarve Line, and Lapure can also be ordered with 'shifted' columns. To give just one example, this can be useful if the pergolas need to extend beyond the patio (but the columns need to remain on the patio), to ensure enough shade is provided even when the sun is low in the sky.

You can also choose shifted columns for placement or architectural reasons. The column can be shifted a maximal 1/5 of the total Pivot length.



BLADE ROTATION DIRECTION

Blade rotation direction is important for the Camargue Line, Algarve Line, and Aero Line. Do you want sun protection for as long as possible or allow sunlight to flood in as quickly as possible?

Renson® lets you choose. When adding a pergola to a kitchen or a living room, for example, people usually want to admit light as quickly as possible.

- ① The blades rotate as standard so that southern sunlight is blocked when they are opened. Sunlight can also be allowed in with standard sun protection blades by rotating them further.

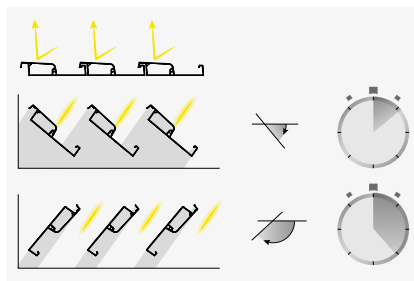

- ② Blades that let the sunlight in move into the correct angle more quickly and the smooth, attractive bottom side remains visible.

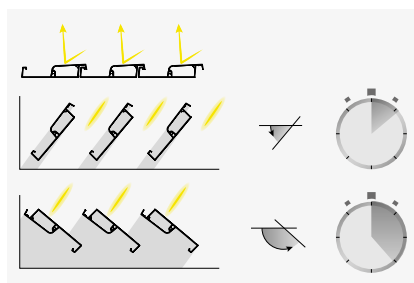

BLADE COLOR

Camargue Line, Algarve Line, and Aero Line are available in dual color (i.e. with roof blades in a different color than the frame and columns) at no extra cost.

Tip: if your structure has a dark color, select a lighter color for the blades. A darker roof blade color creates the impression of a lower ceiling. A lighter color creates a sense of more space and has additional sun and heat protection properties.



VERANDA

Is a pergola like the Camargue Line or Algarve Line similar to a veranda?

No! A veranda is an extension of the living space enclosed in glass and creates an enclosed space that is completely wind and waterproof. In contrast, a pergola is an open aluminum structure with a roof of rotating, aluminum blades that (possibly combined with side panels) primarily offers shelter from the sun and, to a certain extent, bad weather. The climate under a pergola is essentially that of the outdoors, allowing users to enjoy the ambience, scents, colors, and sounds of the garden.

Condensation may form on the bottom side of the blades in cold weather.

Therefore, it is best to place weatherproof garden furniture under a Camargue Line or Algarve Line.

WIND - CAMARGUE LINE AND ALGARVE LINE

If high winds are forecast, we recommend closing the bladed roof (possible with wind speeds of up to 31 mph). Closing the bladed roof makes the entire structure more rigid, meaning it can withstand high winds much better. We also offer a warranty on our Camargue Line and Algarve Line with the roof closed for wind speeds of up to 99mph for the Camargue and 74mph for the Algarve!

FABRIC OR BLADES?

How do I choose between a pergola with a bladed roof (Camargue Line and Algarve Line) or a screen roof (Lapure)?

Each type of pergola has its own advantages. A pergola with a sun protection fabric can be opened up completely. This allows you to keep sunlight out or allow it to enter across the full extent of the roof, depending on the weather conditions. Pergolas with roof blades allow users to control the amount of sunlight based on their requirements; when there is too much sunlight, the blades can be closed completely, but the roof can never be opened up completely to maximise the amount of sunlight.

	Bladed roof	Screen roof
Roof	Horizontal	Always at an angle
Position	Surface-mounted, recessed, or freestanding	Only surface-mounted
View when roof is 'open'	Roof blades rotate open but don't 'disappear'	'Roof' completely disappears
Light if the roof is 'closed'	Opaque (except Lineo Luce blades)	Translucent
Load-bearing capacity	Can bear snow	Cannot bear snow
Color of the roof	All possible colors	Limited range of colors available for fabric screen roof

LOW SUN: ZIPSHADE

When the sun is low in the sky, sunlight can come in underneath the pergola and into your home. This is a great way to warm your house up naturally in winter. However, this sunlight can be disruptive at times and may cause temporary blinding, discoloration or reflections on TV and computer screens. Sunlight can be blocked by vertical sun protection fabric (Zipshade) in the sides of your pergola (Camargue Line). Because Zipshade fabric is translucent, you maintain contact with the outdoor environment.



PASSAGE HEIGHT

The passage height of a bladed roof (Camargue Line and Algarve Line) can be freely chosen. People usually choose a height based on their specific circumstances (e.g. for a construction situation, there might be a rain gutter or window in the way) or for personal reasons; tall people might prefer a higher passage height to create more 'openness'. For the most shade, however, it is best to have the lowest possible passage height.



PATIO, DECK OR TERRACE ORIENTATION

Depending on the orientation of your patio, you can decide to position your pergola differently. Pergolas with fabric (Lapure) or adjustable blades (Camargue Line and Algarve Line) are both good solutions for a south-facing patio. You can keep the heat of the sun at bay by rolling out the fabric or closing the blades. For a bladed roof, blades should be placed parallel to the home. This gives you maximum control over the amount of sunlight that enters: you can choose to keep the light out entirely, partially or allow it to flood in.

For a north-facing patio, it is a good idea to install the blades perpendicular to the wall. This is the best way to control the light coming in from the east and west, while allowing the maximum amount of light to enter with the roof open.



■ E-NE-N-NW-W: blades perpendicular to the wall.
■ SW-S-SE: blades parallel to the wall.

THE MOST FREQUENTLY ASKED QUESTIONS ABOUT RENSON® PERGOLAS...

CAN A RENSON® PERGOLA BE MADE TO MEASURE?

All Renson® covers are custom-made to within a millimetre, at no extra cost.

WHAT ARE THE MAXIMUM DIMENSIONS?

That depends on the type of cover. Please consult the product table in this brochure. This table shows the possible dimensions of one roof module. Modules can be joined to obtain larger dimensions.

WHICH COLORS ARE POSSIBLE?

The top 100 RAL colors are available in textured coating at no extra cost.

This allows you to match the color of your pergola to the joinery of your home. The blades can be chosen in a top 100 RAL color other than the structure at no extra cost.

DOES THE COVER ALWAYS HAVE TO BE PLACED AGAINST A WALL OR IS FREESTANDING ALSO AN OPTION?

Pergolas with bladed roofs (Camargue line and Algarve line) can either be placed as freestanding or against a building.

Pergolas under an incline, with a screen or fabric roof, can only be built against a house or other construction.

The Aero roofs are specially designed to be built into a new or existing support structure.

DON'T THE BLADES IN THE ROOF KEEP OUT TOO MUCH LIGHT?

You have full control over the intensity of the light with blades.

When closed, there is no light transmission. Alternatively, you could install a few glass or LED blades for more light.

When the blades are slightly rotated, a significant amount of light floods in quickly.

With the Camargue Skye, you can not only rotate, but also slide the blades to one side. This gives you a completely open roof.

IS A BLADED ROOF COMPLETELY WATERPROOF?

In addition to sun protection, bladed roofs and Zipshade roofs also offer full protection from the rain. However, you should bear in mind that a pergola is an open aluminum structure, not to be confused with a veranda. Furniture and floors must therefore be suitable for outdoor use.

WHAT OPTIONS ARE POSSIBLE FOR PERGOLAS?

Renson® covers can be equipped with a wide range of accessories and thus perfectly configured to your personal taste. (Zipshade sun protection, Loggia sliding panels, glass sliding panels, lighting, heating, music, etc.)

CAN I ALSO ENJOY MY PERGOLA DURING THE OTHER SEASONS?

Absolutely! The best way is to equip the cover with the appropriate side inserts (Zipshade, Loggia, or glass sliding panels). Lighting and heating are also among the possibilities to enjoy in all seasons all year round.

HOW SHOULD I CLEAN THE PERGOLA?

Your Renson® cover will be fully exposed to the elements for years – day in, day out. If you want to enjoy it optimally at all times, we recommend cleaning it annually with Renson Maintenance Set products. This maintenance set products will ensure that the intense color is maintained for years, as well as providing extra protection from acid rain, sea air, and UV radiation (see also the extended warranty for annual use).

WILL A PERGOLA INCREASE THE VALUE OF MY HOUSE OR PROPERTY?

Of course. Official estimates of homes with a Renson® cover also include this in the valuation of the property.

Investing in a Renson® cover is therefore an immediate way to increase the value of your home!

DOESN'T IT GET TOO HOT UNDER A BLADED ROOF?

Not only does a bladed roof provide protection from the sun, it also ventilates. If the air under the cover warms up too much, a ventilation effect can be created by simply rotating the blades slightly, so that the warm air flows away through the roof.

HOW LONG DOES IT TAKE THE HEATER TO REACH MAXIMUM HEAT?

Because we work with a short-wave system, the heater reaches maximum heat radiation almost immediately. Short-wave radiated heat is directly palpable, similar to the heat of solar radiation. You heat up the objects and not the space. Long-wave infrared heaters have a longer warm-up time than short-wave heaters. They need air to transmit heat. Depending on the ambient temperature, size of the cover, if it's closed or not, etc., it can take some time before you feel the maximal radiated heat.

BEAM HEAT & SOUND

PERFECT HEATER POSITION

The perfect position for the Beam with heat is opposite a fixed wall so that you can enjoy the reflected warmth.

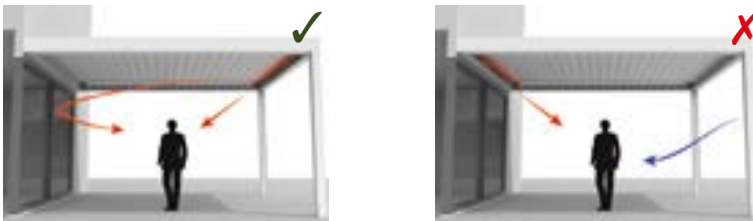

HEATING COMBINED WITH ENCLOSURE ELEMENTS

To enjoy your heater to the fullest, we recommend adding components (such as glass walls, Zipshade, etc.) that will enclose the sides of the pergola.



LINEO HEAT

The heat diagrams below show the heat distribution for 1 and 2 Lineo Heat blades. For optimal heat distribution when using 2 Lineo Heat blades, we recommend placing them at a distance of 59 in from each other.

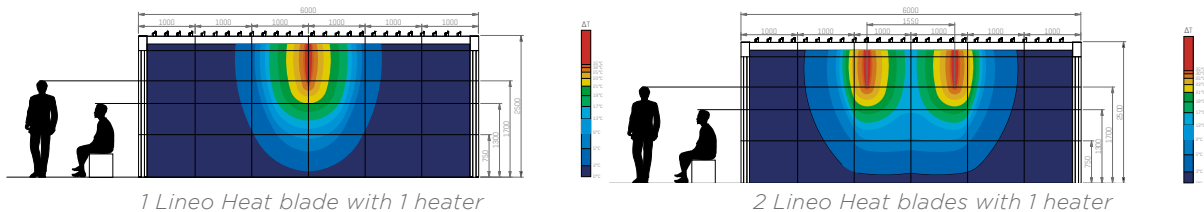

WHAT IS THE SOUND LEVEL OF RAIN WHEN IT FALLS ON A PERGOLA?

The sound level depends largely on the intensity of the rain and cannot easily be quantified. In covers with a screen roof, the amount of noise is comparable to rain falling on a tent. In covers with a bladed roof, you'll hear a muffled metallic sound. As we use double-walled blades, the noise is less sharp than with single-walled blades. In covers with a fixed roof (Algarve Canvas and Aero Canvas), rain falls directly on the steel roof. The anti-condensation layer on the roof slightly dampens the sound of rainfall, so it doesn't sound too sharp. The sound level on a fixed roof can be compared to that of a bladed roof in the same amount of rain.

HOW LONG DOES A PERGOLA INSTALLATION TAKE?

It usually only takes a day for the cover to be placed. Depending on the number of options and inserts, the installation process may take two days. This does not include any foundation works.

CAN THE ROOF BLADES BE OPERATED IN FROSTY CONDITIONS?

If the blades are not fully closed, you can continue to operate them in frost. If the blades are fully closed, condensation between the blades may cause them to freeze shut. In this case, the roof should not be operated.

WILL ZIPSHADES OBSTRUCT MY OUTSIDE VIEW?

The transparency of Zipshades is affected by the amount of light they reflect. In bright, sunny weather, it is nearly impossible to see into the pergola from the outside. On the other hand, when you switch the LED lighting on in the evening, it will be less easy to look outdoors from inside the pergola. A darker-colored screen will reflect less light, which makes it easier to see through than a light-colored screen. Our Privacy fiberglass fabrics have a more tightly woven structure with just 1% openness, meaning even darker-colored fabrics are much less transparent.



Camargue® & Camargue® Skye
Frame RAL 9004
Blades Wooddesign walnut
Zipshade Natté N3006
Glass wall



TECHNICAL INFORMATION

CAMARGUE® LINE

The Camargue Line is a series of innovative pergolas with a modular structure that can be expanded as required and closed on all sides with integrated side elements.

THE CAMARGUE LINE INCLUDES TWO TYPES OF COVERS:

- Camargue: with rotating blades
- Camargue Skye: with rotating and sliding blades



Camargue® + Camargue Skye®

MODULAR DESIGN

Expandable to include multiple roof sections, even after initial installation. The structure can be endlessly expanded on both the Span and Pivot side to cover large surface areas.



THE FABRIC ROLLER TUBE IS FULLY INTEGRATED INTO THE STRUCTURE

No visible screen head box disrupting the aesthetic

THE BOTTOM BAR DISAPPEARS INTO THE HEAD BOX



INTEGRATED ZIPSHADE SIDE GUIDING CHANNELS IN THE COLUMNS

Full aesthetic integration with the Camargue structure



INTEGRATED WATER DRAINAGE WITH LARGE AIRFLOW

Through the wide blade gutters, water flows towards gutters with diffusers to prevent splashing before being drained via PVC drainpipes integrated into the columns.

Camargue® + Camargue Skye®

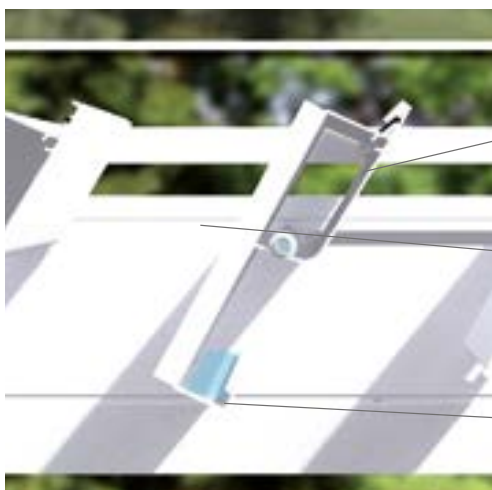

DOUBLE-WALLED BLADES FOR EXTRA STRENGTH

Load-bearing capacity: 19 kg/ft²

WELDED ALUMINUM DRIPS, POWDER COATED TO MATCH THE COLOR OF THE ROOF BLADES



SPECIALLY DEVELOPED GUTTER BORDER

Prevents your patio and furniture from getting wet when the blades are opened following a rain shower

Camargue® + Camargue Skye®



F2 TECHNOLOGY

With a Span system that ensures the rigidity of its support structure, Camargue remains stable even in strong winds.

Camargue®

S-DRIVE TECHNOLOGY

Reliable and durable rotating and sliding technology



SYNCHRONISED DRIVE ON BOTH SIDES OF THE BLADES

Even with an asymmetric load, the roof will open and close in one smooth movement

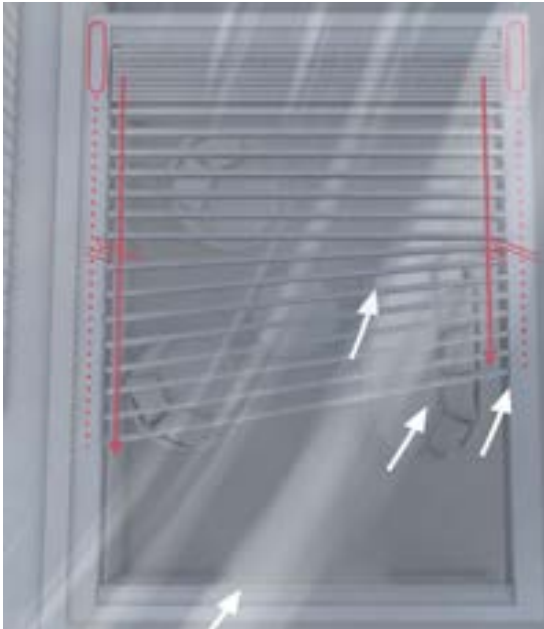

'TRAIN' SYSTEM (OTHER BRANDS ON THE MARKET)

Only the first blade (the locomotive) is driven, and all other blades (the carriages) are passively pulled along.

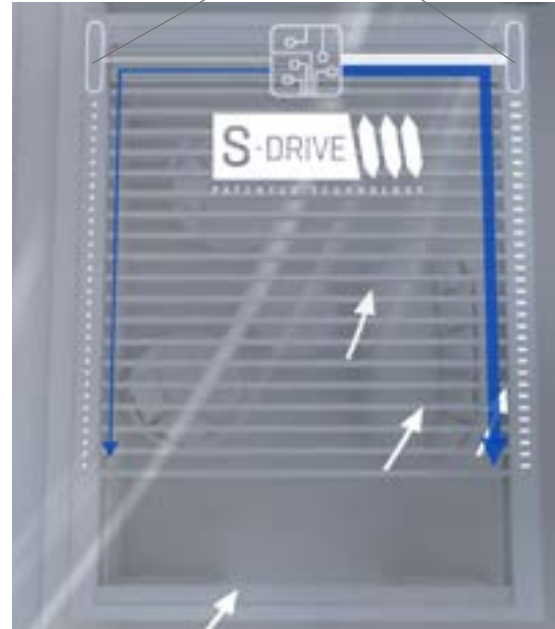

RENSON® S-DRIVE

Driven by a spindle that evenly distributes traction across all blades.

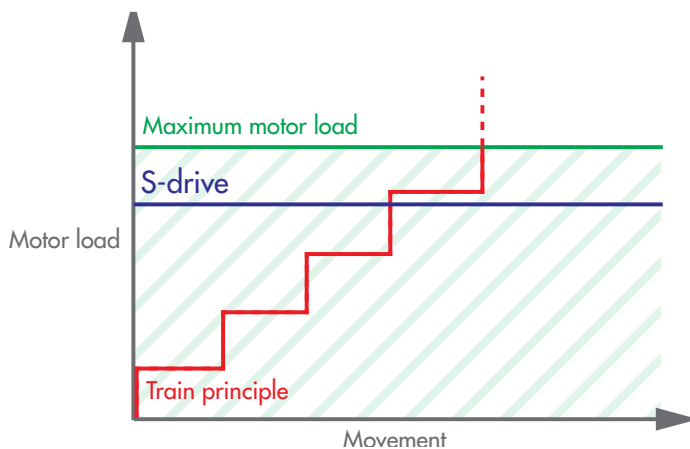

INNOVATION



SPINDLE FOR SLIDING BLADES

TROLLEYS ON RAILS ENSURE SMOOTH AND STABLE MOVEMENT

Each blade is driven individually

HEXAGONAL AXLE FOR ROTATING BLADES

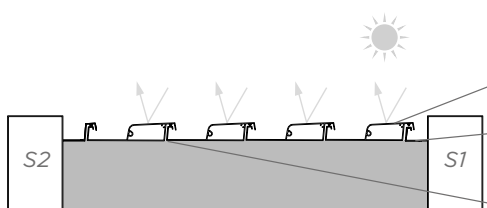

STRONG, DOUBLE-WALLED BLADES CAN HANDLE HEAVY SNOW LOADS

THE ROOF IS COMPLETELY FLAT WHEN CLOSED

NO GAPS BETWEEN THE BLADES

INSTALLATION OPTIONS CAMARGUE® LINE

TYPES OF INSTALLATION

There are 2 types of installation possible for the Camargue Line: freestanding and wall mounting.



Freestanding: the frame of the Camargue is supported by four vertical columns.



Façade mounting: the frame is placed with one or two sides against an underlying, supporting construction or structure. Vertical columns support the other part. The blades can be positioned parallel or perpendicular to the support structure.

JOINED

The Camargue Line can be joined using one of the larger Spans or Pivots to cover larger surface areas. In this case, a coupling side beam is used.



Camargue joined on Pivot side



Camargue Skye two-part joined on the Span side, similar slide direction and orientation



Two-part joined on the Span side



Camargue joined on the Pivot and/or Span side



Camargue Skye two-part joined on the Span side, opposing slide direction and orientation

INTEGRATED ZIPSHADE®

By integrating the vertical sun protection, the integrated Zipshade, with or without Crystal Windows to maximise a view of the outside, you can create an extra outdoor room where users are protected from sun, rain, and wind. These screens come in 50 colors and allow you to customise the Camargue Line and create the atmosphere you desire.



The Camargue Line is fitted with the integrated Zipshade in the Span and Pivot side

CUSTOMIZATION OPTIONS

The Camargue Line can have various elements fitted to the front and/or sides. By adding side elements, you create infinite possibilities for Customization.



Loggia sliding panel: Loggia-wood, Loggia-wood Privacy, Loggiascreen Canvas, Loggialu, Loggialu Privacy



Glass sliding panel + integrated Zipshade



Loggia easy passage: Loggiascreen Canvas



Linus fixed walls: full passage height or desired height + Linarte fixed wall



Glass sliding panels



Curtains

MOUNTING BASES

Mounting bases are available in visible (whether or not against a building), invisible, or cast-mounted. If side inserts are used or this is used in locations with increased wind forces, reinforced visible and invisible mounting bases are available to guarantee the extra stability the construction requires.

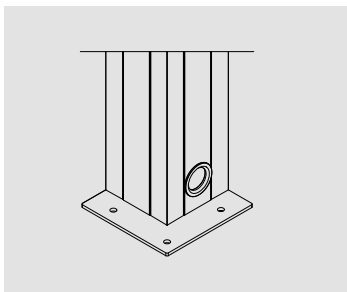

Visible mounting base

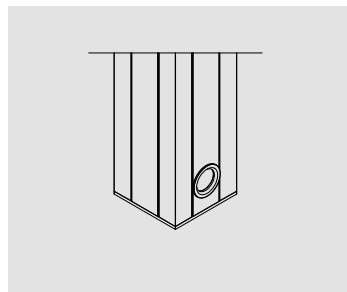

Invisible mounting base

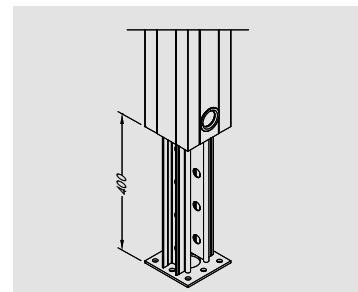

Cast mounting base

ALGARVE® LINE

The Algarve Line is a series of elegant aluminum pergolas that can be closed with surface-mounted side elements.



THE ALGARVE LINE INCLUDES 2 TYPES OF COVER:

- Algarve: with rotating aluminum roof blades to control sun protection and ventilation
- Algarve Canvas: with a horizontal, rigid, water-draining fixed roof and aesthetically finished lower roof made of tautly stretched fabric using Zipshade technology



MINIMALIST DESIGN

Sleek profiles and invisible screw joints combine to create an elegant structure. In the Algarve bladed roof, that's made possible by a motor subtly hidden on the top of the frame to add to the overall aesthetic.

TWO-PART JOINED

Two roof sections can be joined to create a maximum 65 x 65 ft Span without any additional columns. The roof sections can be fitted with a bladed or canvas roof, and a combination of blades and canvas is also possible. There is no need for both roof sections to have the same finish.

SURFACE-MOUNTED SIDE ELEMENTS

Zipshades, glass sliding panels, Loggia panels, fixed walls or outdoor curtains can be fitted to the structure as surface-mounted elements.



Algarve®



F2 TECHNOLOGY

With a secure fastening system that ensures the rigidity of its support structure, Algarve remains stable even in strong winds.



DOUBLE-WALLED BLADES FOR EXTRA STRENGTH

Load-bearing capacity: 220 lbs/ft²

WELDED ALUMINUM DRIPS, POWDER COATED TO MATCH THE COLOR OF THE ROOF BLADES

SPECIALLY DEVELOPED GUTTER BORDER

Prevents your patio and furniture from getting wet when the blades are opened following a rain shower

Algarve®



WATER DRAINAGE VIA RIGID UPPER ROOF

Equipped with a leaf catcher to prevent blockages and an anti-condensation layer to prevent drops from forming on the underside of the roof

INTEGRATED WATER DRAINAGE

Via gutters all around the structure

Algarve® Canvas



RIGID, WATER-DRAINING UPPER ROOF

Made of profiled steel sheets
Load-bearing capacity: > 220 lbs /ft²



AESTHETIC LOWER ROOF

Made of tautly stretched fabric with Zipshade technology



PERFECT FINISHING

Sealing profile stops dirt and insects

Algarve® Canvas

INSTALLATION OPTIONS ALGARVE® LINE

TYPES OF INSTALLATION

The Algarve Line includes two possible types of installation: freestanding and wall mounting.

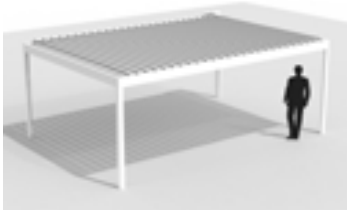

Algarve - Freestanding



Algarve Canvas - Freestanding

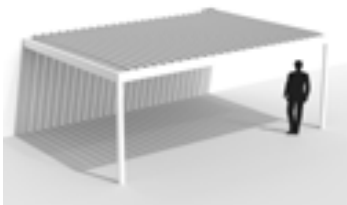

Algarve - Façade mounting



Algarve Canvas - Façade mounting

TIP

Thanks to its smart design, Algarve Canvas can be extended. By closing off the walls, you can also create an adjoining storage room. That way you can safely store bikes, garden furniture, the lawnmower, etc. while conserving space in your home. The extension of an Algarve Canvas carport can be done along both the length and width of the carport:



*Example of an extension in length:
7 x 3.5 metres*



Example of an extension in width: 5 x 5.5 metres

CUSTOMIZATION OPTIONS



Loggia

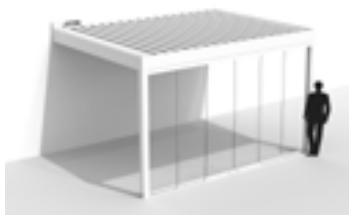

Glass sliding panels



Surface-mounted Zipshade

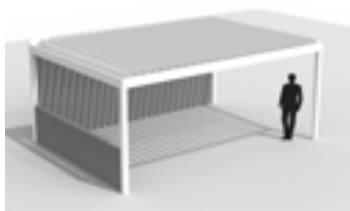

Linius fixed wall

TIP

The Algarve Line with one or two Zipshades combined with 2 Lineo LEDs is available as an affordable Comfort Pack.

ALGARVE® ZIPSHADE®

To close the sides of an Algarve Line pergola, they can be combined with an Algarve Zipshade. This allows the sun protection head box to be installed underneath the frame profiles so that it connects perfectly with the basic construction.

JOINED

Algarve can be joined in two parts (widthwise) so that exceptional surface areas of 20 x 20 ft can be covered without middle columns disrupting the view. Moreover, the Algarve Line in its joined version is perfectly feasible with a bladed roof in one part of the roof and a fixed roof in the other part.

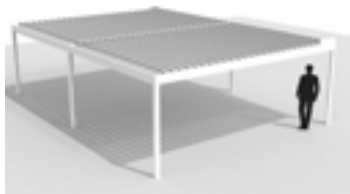

Algarve - two-part joined on the Span side



Algarve joined with Algarve Canvas

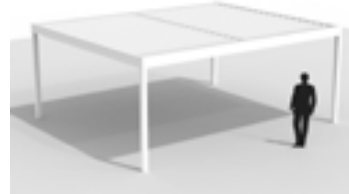

Algarve Canvas - two-part joined on the Pivot side



The Aero Line is a series of functional roofs customised to the mm that integrate beautifully into a fixed structure.

THERE ARE 3 TYPES IN THE AERO LINE:

- Aero: with a rotatable bladed roof
- Aero Skye with rotatable and sliding bladed roof
- Aero Canvas: with a horizontal, rigid, water-draining fixed roof and aesthetically finished lower roof made of tautly stretched fabric using Zipshade technology



WATER DRAINAGE VIA RIGID UPPER ROOF

With a leaf catcher to prevent blockages

INTEGRATED WATER DRAINAGE

Via gutters all around the structure

Aero[®] Canvas



AESTHETIC, HORIZONTAL LOWER ROOF

Tension ceiling with Zipshade technology for outdoor use

Aero[®] Canvas



INNOVATION

F2 TECHNOLOGY

Every blade is secured to the frame to create a strong and stable structure

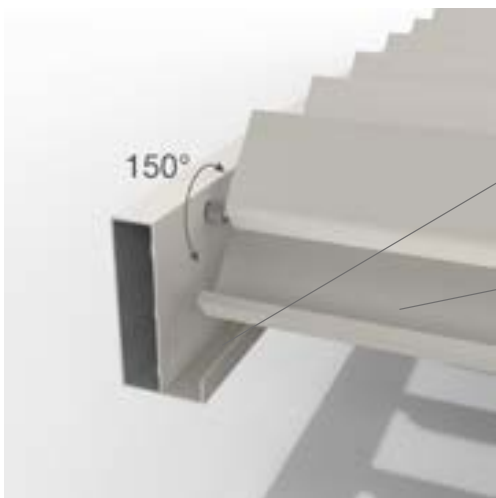

SPLASH PREVENTION

Via integrated water channels with diffusers

HIGH WATER DRAINAGE FLOW

Through the wide blade gutters

Aero®

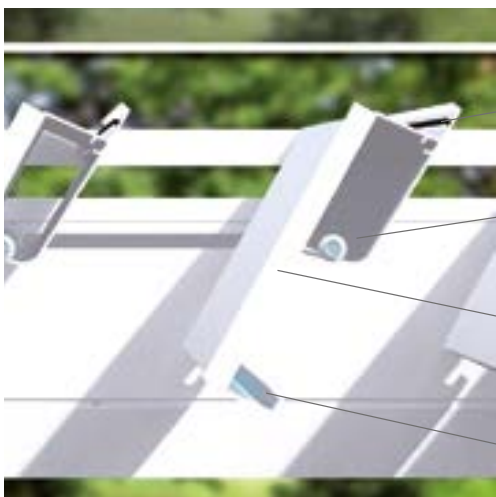

BRUSHES ENSURE BLADES CLOSE GENTLY AND PREVENT THEM FROM FREEZING SHUT

DOUBLE-WALLED BLADES FOR EXTRA STRENGTH

Load-bearing capacity: 220 lbs/ft²

WELDED ALUMINUM DRIPS, POWDER COATED TO MATCH THE COLOR OF THE ROOF BLADES

SPECIALLY DEVELOPED GUTTER BORDER

Prevents your patio and furniture from getting wet when the blades are opened following a rain shower

Aero®

LAPURE®

Minimalist pergola with a water and wind-resistant sun protection Zipshade roof and an open, panoramic view. Can be closed with surface-mounted side elements.

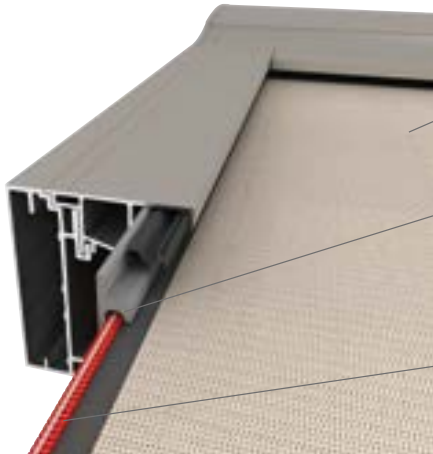

WATERPROOF, TRANSLUCENT FABRIC

DURABLE INNER RAIL WITH SMOOTH TECHNOLOGY

For smooth, durable, and silent zip operation

SYMMETRICAL ZIP ENSURES HIGH WIND RESISTANCE

High wind guarantee up to 60 mph

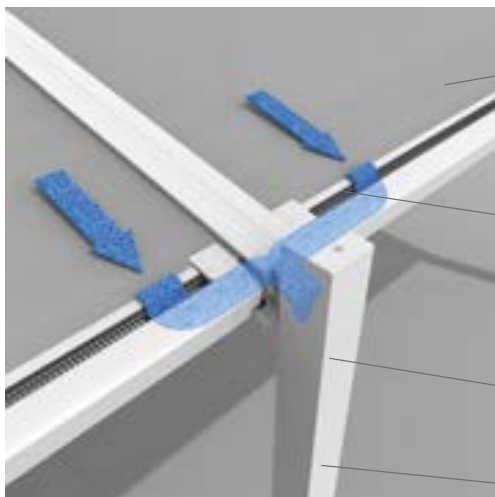

JOINED IN MULTIPLE PARTS

Can be joined in multiple parts to cover large surface areas

INTEGRATED WATER DRAINAGE VIA BOTTOM BAR AND SIDE GUIDING CHANNELS

Water drainage even if the roof is not fully closed

WATER IS DRAINED VIA THE COLUMNS

SHIFTED COLUMNS ARE POSSIBLE



UNINTERRUPTED PANORAMIC VIEW

No visible front bar when fabric is retracted

LAPURE® INSTALLATION OPTIONS

TYPES OF INSTALLATION

1 ROOF SECTION

Without roof overhang
(with 'end columns')



With roof overhang
(with 'shifted' columns)



2 ROOF SECTIONS



3 ROOF SECTIONS

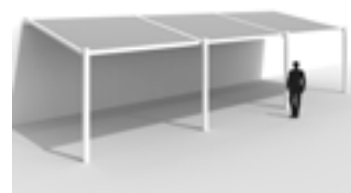

CUSTOMIZATION OPTIONS

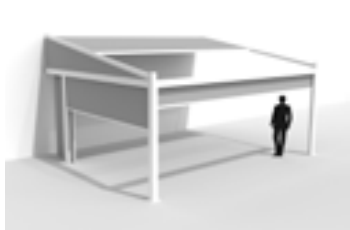

Lapure fitted with a Zipshade and sliding door using Loggia-screen Canvas in the side







The Lapure 'Classic Line' creates a classic, traditional style by adding decorative elements: stylised columns and finials in a globe or diamond shape.



1 roof section between 13 and 19 ft: including a cross-beam (with or without LED)





RANGE

HORIZONTAL DESIGN					
CAMARGUE® LINE					
ALGARVE® LINE					
TYPE	Camargue®	Camargue® Skye	Algarve® 	Algarve® Canvas	
					
ROOF INSERTS	Rotating blades	Rotating and sliding blades	Rotating blades	Fixed roof	
DIMENSIONS					
Max. width / Pivot	244"/278" ***	244"	238 2/5		
Max. depth / Span	177 1/6		177 1/6 / 236 2/9 *		
Max. passage height	110 1/4		110 1/4		
Joined	joined in multiple parts		two-part joined		
Min. incline	no incline (0°)		no incline (0°)		
Max. blade rotation	150°	145°	150°	-	
ACCESSORIES					
SIDE ELEMENTS	Integrated Zipshade®	option	option	-	-
	Surface-mounted Zipshade	-	-	option	option
	Loggia sliding panels	option	option	option	option
	Loggiascreen Canvas easy passage	option	option	-	-
	Glass walls	option	option	option	option
	Linus Wall	option	option	option	option
	Linarte Wall	option	option	-	-
	Triangle	-	-	-	-
	Outdoor curtains	option	option	option	option
	Extra column	option	option	option	option
	Shifted column	option	option	option	option
LIGHTING	Adjustable wall profile	option	option	-	-
	Lineo LED	option	-	option	-
	UpDown LED	option	option	option	option
	Colomno LED	option	option	-	-
COMFORT & DESIGN	Lapure LED	-	-	-	-
	Beam Heat & Sound	option	option	option	-
	Translucent Lineo Luce blades	option	-	option	-
	Lineo Fix / Heat	option	-	option	-
Wooddesign	option	option	option	-	

* > 177 1/6 is possible when joined, up to max. 236 2/9

** up to 157 1/2 without cross-beam > 157 1/2 to 236 2/9 with cross-beam

*** Pivot > 244" is possible in one roof section if an extra column is used, up to a max. Pivot of 278

HORIZONTAL DESIGN		SLOPED DESIGN	
AERO® LINE		LAPURE®	
Aero® 	Aero® Canvas	Aero® Skye	Lapure®
			
Rotating blades	Fixed roof	Rotating and sliding blades	Retractable, waterproof, translucent, and sun protection screen
238 2/5	238 2/5	244"	236 2/9 **
177 1/6 / 236 2/9*	177 1/6 / 236 2/9*	177 1/6	196 6/7
-	-	-	114 1/6
two-part joined	two-part joined	joined in multiple parts	up to a max. width of 59 ft
		no incline (0°)	10°
150°	-	145°	-
-	-	-	-
-	-	-	option
-	-	-	-
-	-	-	option
-	-	-	-
-	-	-	-
-	-	-	-
-	-	-	option
-	-	-	-
-	-	-	option
-	-	-	option
-	-	-	-
option	-	-	-
option	option	option	-
-	-	-	-
-	-	-	option
option	-	option	-
option	-	-	-
option	-	-	-
option	-	option	-

DESIGN AND OUTDOOR LIVING IN A UNIQUE TOTAL EXPERIENCE PARK

Thirty international partners are turning NOA into the most exclusive event in the world of unique outdoor living. Instead of isolated products, NOA presents scenes that have been designed and styled according to the latest trends to create stylised masterpieces for the most diverse gardens.



1250 FEET LONG FAÇADE





AUTOMATED HIGH-RISE BUILDING 85 FT

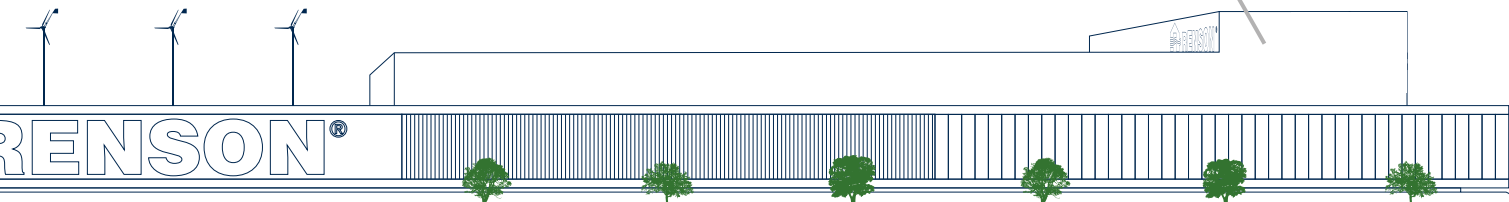

SUSTAINABILITY

Renson takes care of your health and the environment. Our brand new site in 'De Prijkels' in Kruisem, Belgium, puts sustainability first. From our choice of aluminum as a raw material to the site's infrastructure and the environment, we have done everything possible to complete the circle of sustainability and recycling.

Did you know that the new production facility for our covers, extending over 32.2917 ft², is completely self-sufficient in terms of energy and water consumption?

A UNIQUE OUTDOOR EXPERIENCE CENTRE...

With our new site in Kruisem, we are going full steam ahead. The building was designed as a large XL canopy along one of the busiest motorways in Europe. With a 'green concept' as a backdrop, literally and figuratively, the 1250-foot-long façade was built using natural elements and solutions from the Renson Outdoor range. The building's orientation and layout were designed to minimise energy consumption.

The remaining active heating and cooling are powered by Biothermal Solutions (BTES), combined with heat pumps.



**70% LESS ENERGY
CONSUMPTION AND
CO₂ EMISSIONS**

The Renson Outdoor HQ uses approximately 70% less energy and generates around 70% fewer CO₂ emissions than standard office buildings and production sites



THE LIFE CYCLE OF ALUMINUM

Our main component: Aluminum. It is the primary raw material used in our products. In comparison to other raw materials, it has a unique life cycle. It is resistant to corrosion and can be completely recycled over and over again.

Alu is a first-class building material and can be redesigned and adapted to the challenges of any time.

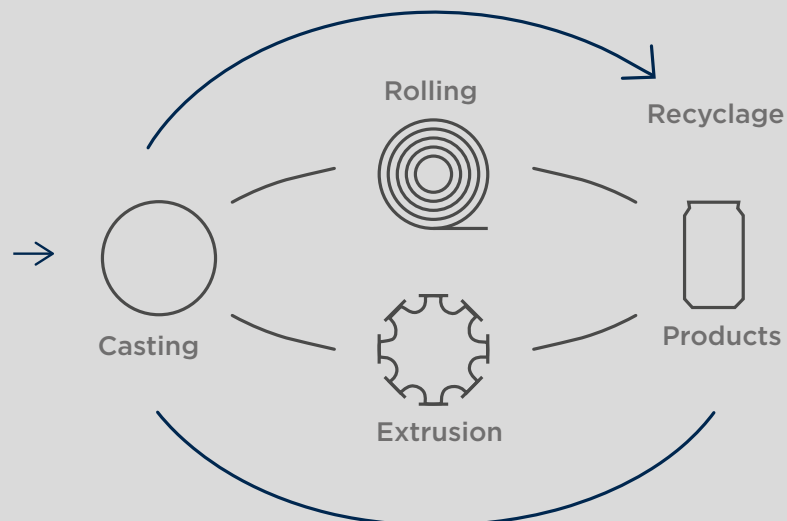
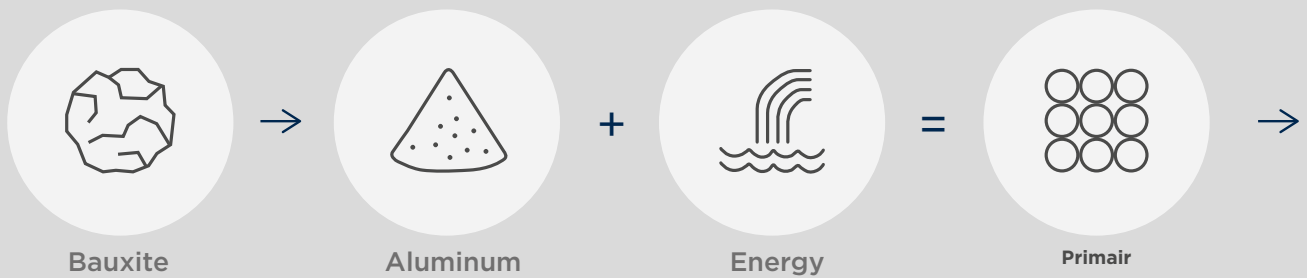
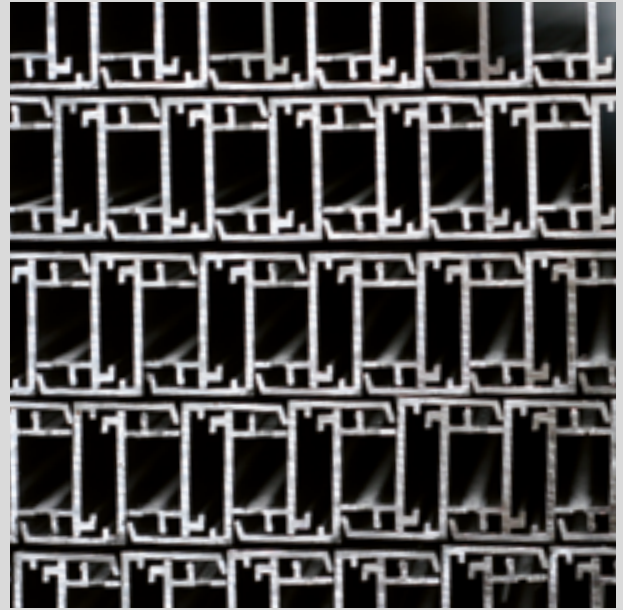



**BUILDING OR RENOVATIONS PLANS?
VISIT OUR SHOWROOMS IN BELGIUM
NOA – KRUISEM**

Monday to Friday: Monday to Friday: 8:30 a.m. – noon
and 1:30 p.m. – 6 p.m.
Saturday: 9 a.m. – noon

Polydore Rensonstraat 8 – 9770 Kruisem – Belgium
www.noa-outdoor.com

EXIT 5 – WAREGEM

Monday to Friday: Monday to Friday: 8:30 a.m. – noon
and 1:30 p.m. – 6 p.m.

Saturday: 9 a.m. – noon

Make an appointment by phone on
+32 (0)56 62 96 87 or online at www.exit5.be
Maalbeekstraat 10 – 8790 Waregem – Belgium
www.exit5.be

NY SHOWROOM – USA

Ernest NY • 255 5th Avenue • 6th Floor • NY 10016
+1 310 658 4878



SHANGAI SHOWROOM – CHINA

No 33, Lane 672, Changle Rd
Jingan District
Shanghai, China
Tel: +86 21 6418 2566





WHO CAN I CONTACT FOR RENSON® PRODUCTS?

In order to guarantee that our high-quality and durable products are also placed professionally, we have built up a network of well-trained Ambassadors and Installers.

RENSON® PREMIUM AMBASSADORS

Renson ambassadors have years of experience in the sale and installation of Renson® products. They keep up-to-date on the complete range and guarantee the very best professional assistance.

RENSON® AMBASSADORS demonstrate our products in their showrooms and ensure that everything is placed professionally and correctly. They also guarantee a professional after-sales service.

Also see www.renson.eu



YOU CAN ALSO
 DOWNLOAD OUR OTHER
 INSPIRATION
 BROCHURES AT
 WWW.RENSON.EU



VENTILATION



SUN PROTECTION



FAÇADE
 CLADDING

All photos shown are solely for illustration purposes and are a snapshot of the usage situation. The actual product may vary due to product modifications. Renson® reserves the right to make technical changes to the products shown. You can download the most recent brochures at www.renson-outdoor.com



RENSON® USA
 1910 North Josey
 Carrollton TX 75006
 usa@renson.net
 www.rensonusa.com

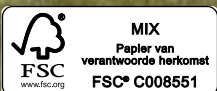

USA 05/22 L0000370